

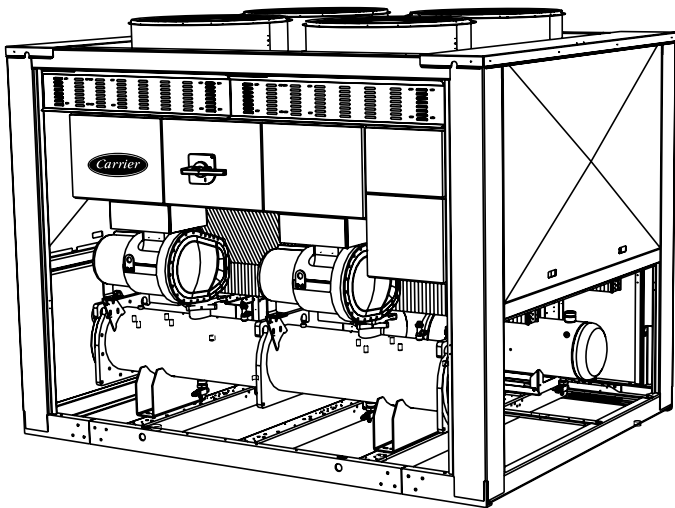

30GX and 30HXC series PRO-DIALOG *Plus* Control

Screw-Compressor Air- and
Water-Cooled Liquid Chillers

50 Hz



GLOBAL CHILLER

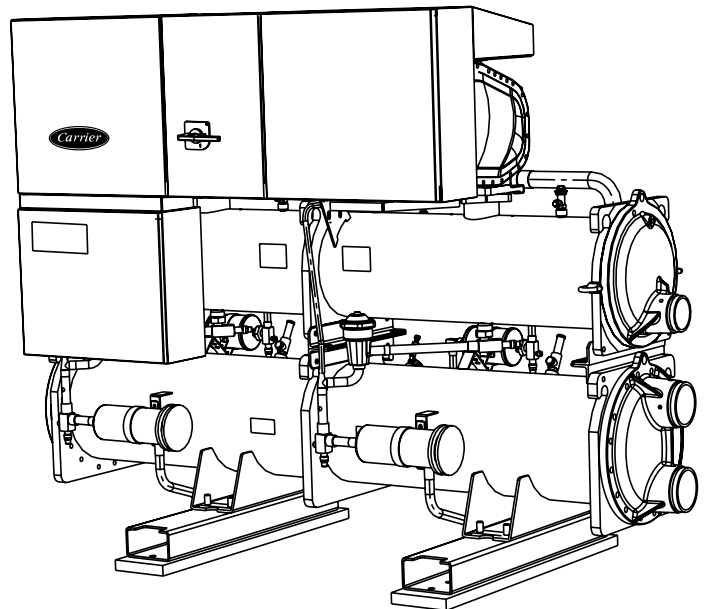

Installation, operation and maintenance instructions



Quality Management System Approval

Contents

1 - SAFETY CONSIDERATIONS	3
1.1 - General.....	3
1.2 - Avoiding electrocution.....	3
2 - GENERAL DESCRIPTION.....	3
2.1 - General.....	3
2.2 - Abbreviations used.....	3
3 - HARDWARE DESCRIPTION.....	4
3.1 - General.....	4
3.2 - Electronic boards	4
3.3 - The controls	5
3.4 - User connections.....	7
4 - SETTING UP PRO-DIALOG PLUS CONTROL.....	8
4.1 - Local interface general features.....	8
4.2 - Unit start/stop control	9
4.3 - Menus	10
4.4 - General menu structure.....	11
4.5 - Menu tree structure.....	12
5 - PRO-DIALOG PLUS CONTROL OPERATION	26
5.1 - Start/stop control.....	26
5.2 - Heating/cooling selection	26
5.3 - Evaporator water pump control	27
5.4 - Condenser water pump control.....	27
5.5 - Control interlock contact	27
5.6 - Evaporator heater control	27
5.7 - Control point.....	27
5.8 - Demand limit	28
5.9 - Limiting the unit running current	28
5.10 - Capacity control.....	28
5.11 - Determining the lead circuit	28
5.12 - Circuit loading sequence	28
5.13 - Compressor start-up sequence in one circuit.....	28
5.14 - EXV control.....	28
5.15 - Motor cooling valve control	29
5.16 - Head pressure control on air-cooled units	29
5.17 - Head pressure control on water-cooled units.....	29
5.18 - Head pressure setpoint selection.....	29
5.19 - High pressure load shedding function	29
5.20 - High current load shedding function	29
5.21 - Start-up procedure - pre-lubrication	29
5.22 - Master/slave assembly	29
5.23 - Controlling Pro-Dialog Plus units with a System Manager	30
5.24 - Optional heat reclaim module.....	30
6 - DIAGNOSTICS - TROUBLESHOOTING	31
6.1 - General.....	31
6.2 - Displaying alarms.....	31
6.3 - Resetting alarms	31
6.4 - Alarm codes	32

The cover illustrations are solely for illustration, and form no part of any offer for sale or any sale contract. The manufacturer reserves the right to change the design at any time without notice.

1 - SAFETY CONSIDERATIONS

1.1 - General

Installation, start-up and servicing of equipment can be hazardous if factors particular to the installation are not considered: operating pressures, electrical components, voltages and the installation site itself (elevated plinths, rooftops and built-up structures).

Only highly trained and qualified installation engineers and technicians, who are fully trained on the product, are authorised to install and start up this equipment.

During all servicing operations, it is important to read, understand and follow all the recommendations and instructions given in the installation and service instructions for the product, including the tags and labels affixed to the equipment, components and any parts supplied separately, and to comply with all other relevant safety regulations.

- Apply all safety codes and practices.
- Wear safety glasses and gloves.
- Use the proper tools to move heavy objects. Move units carefully and set them down gently.

1.2 - Avoiding electrocution

Only personnel qualified in accordance with the recommendations of the IEC (International Electrotechnical Commission) may be permitted access to electrical components. It is particularly recommended that all sources of electricity to the unit be shut off before any work is begun. Shut off the main power supply at the main circuit breaker or isolator.

IMPORTANT:

Risk of electrocution: Even when the main power isolator or circuit breaker is off, it is still possible for certain components such as crankcase heaters and trace heaters to be energised, since they are connected to a separate power source.

Risk of burns: Electrical currents cause components to get hot either temporarily or permanently. Handle power cables, electrical cables and conduits, terminal box covers and motor frames with very great care.

IMPORTANT: Even when the unit is switched off, the power circuit remains energized as long as the unit or circuit disconnect is not open. Refer to the wiring diagram for details. Use the adapted safety guidelines.

IMPORTANT: This equipment uses and emits electromagnetic signals. The tests carried out on this product have shown that it complies with all applicable codes regarding electromagnetic compatibility.

IMPORTANT : If the boards need to be handled wear anti-static gloves to avoid exposing the electronic components to a destructive voltage. Only unpack the boards from their anti-static bag when they need to be installed.

2 - GENERAL DESCRIPTION

2.1 - General

PRO-DIALOG Plus is a system for controlling units which use screw compressors:

- Single or dual circuit
- Air or water-cooled condensers
- Non-reversible heat pumps

PRO-DIALOG Plus controls compressor start-up and demand limits needed to maintain the desired entering or leaving temperature setpoint for water. It automatically sets the position of the electronic expansion valve (if used) to optimise the evaporator charge. It controls operation of the fans (on air-cooled units) or water valves (on water-cooled units) to maintain the correct head pressure in each circuit.

Safety circuits are constantly monitored by PRO-DIALOG Plus to ensure safe operation of the unit. PRO-DIALOG Plus also gives access to a Quick Test program covering all inputs and outputs.

All PRO-DIALOG Plus controls can work in accordance with three independent modes:

- Local mode: the machine is controlled by commands from the user interface.
- Remote mode: the machine is controlled by remote contacts (volt-free contacts, analogue signals).
- CCN mode: the machine is controlled by commands from the Carrier Comfort Network (CCN). In this case a data communication cable is used to connect the unit to the CCN communication bus.

The operating mode must be chosen with the Operating Type selection button described in section 4.2.1.

When the PRO-DIALOG Plus system operates autonomously (Local or Remote mode) it retains all of its own control capabilities but does not offer any of the features of the CCN network.

2.2 - Abbreviations used

In this manual the circuits are called circuit A and circuit B. The compressors in circuit A are labelled A1 and A2. Those in circuit B are labelled B1 and B2.

The following abbreviations are frequently used:

AI	-	Analogue Input
AO	-	Analogue Output
CCn	-	Operating type: CCN
CCN	-	Carrier Comfort Network
DI	-	Discrete Input
DO	-	Discrete Output
EXV	-	Electronic Expansion Device
LED	-	Light Emitting Diode
Loader	-	Compressor capacity step
LOFF	-	Operating type: Local off
rEM	-	Operating type: by remote control contacts
SCPM	-	Compressor Protection Module
SCT	-	Saturated disCharge Temperature
SIO	-	Standard Input/Output - internal communication bus linking the basic board to the slave boards
SST	-	Saturated Suction Temperature

3 - HARDWARE DESCRIPTION

3.1 - General

Control board

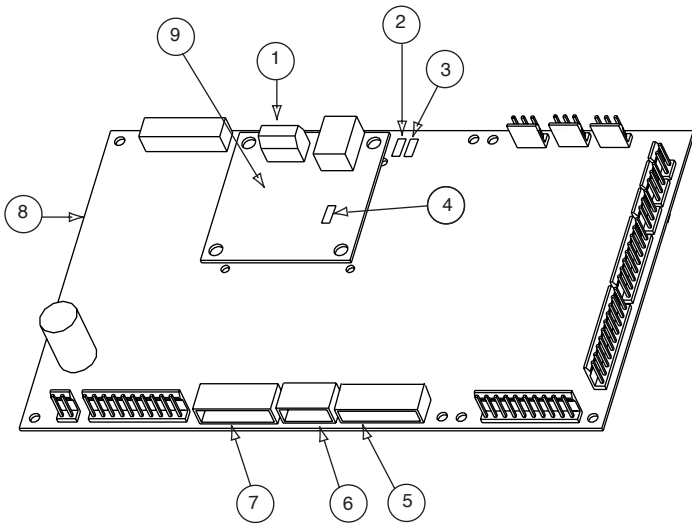

Legend

- 1 CCN connector
- 2 Red LED, status of the board
- 3 Green LED, communication bus SIO
- 4 Orange LED, communication bus CCN
- 5 Remote master board customer control connection contacts
- 6 Remote master board customer control connection signal
- 7 Remote master board customer report connection contacts
- 8 Master PD4 basic board
- 9 CCN/clock board

The control system consists of at least a PD4 basic board, a user interface, a PD4-EXV slave board and, depending on the application, one or more SCPM compressor boards, 8xDO boards (auxiliary type 2) or 8xDO-4xAI-2xAO boards (auxiliary type 1).

Slave boards are connected to the basic board via an internal communication bus (SIO).

The CCN/clock board is connected and screwed to the master basic board. It permits communication with elements of the Carrier Comfort Network via the CCN bus.

The various control components are arranged in modules within the control cabinet:

- **Control module:** This comprises the basic board, the user interface, the EXV control board and option boards, as well as the customer's terminal block.
- **Start-up module:** This consists of the start-up boards, compressor protection boards, as well as the compressor circuit breakers and contactors.
- **Fan module (air-cooled unit):** Consists of one or two 8xDO boards together with the fan circuit breakers and contactors.

3.2 - Electronic boards

3.2.1 - The basic board

It can be used alone or in conjunction with slave boards. It holds the program that controls the machine. It continuously manages the information coming in from the various pressure and temperature sensors, and communicates with the slave boards via the SIO bus. It can also communicate with elements of the Carrier Comfort Network via the CCN bus.

NOTE: After a power cut the unit restarts in the same operating mode as before the power cut.

3.2.2 - Slave boards

- **Compressor board SCPM:** This board is used to control a compressor. Up to four SCPM boards can be connected to the basic board. It also controls the inputs and outputs connected to the compressor, such as oil level, oil pump, loaders, motor cooling valves, etc.
- **8xDO board (auxiliary type 2):** This board can be used to control fan stages.
- **PD4-EXV board:** This board can control two EXV valves.
- **8xDO-4xAI-2xAO board (auxiliary type 1):** This optional board allows:
 - control of the fan stages
 - reading the temperature in the heat reclaim condensers
 - control of the variable-speed fans (air-cooled units) or the condenser valve (water-cooled units).

Control box

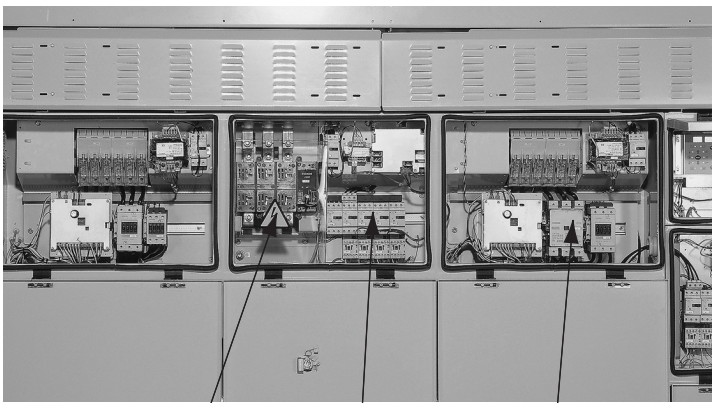

Legend

- 1 Power supply disconnect switch
- 2 Fan start-up module
- 3 Compressor start-up module
- 4 Control system
- 5 User interface

3.2.3 - The user interface

The user interface is in two parts:

- **The main interface:** This gives access to all of the control parameters for the unit. It consists of a 2-digit primary display block and a secondary 4-digit display block with 10 LEDs and 5 buttons.
- **The summary interface:** This gives quick access to just the main control parameters for the unit. It comprises 12 buttons and 16 LEDs, and includes a schematic diagram of the unit.

3.2.4 - Connections between boards

The basic board and slave boards communicate with each other over an internal three-wire RS485 communication bus (SIO bus). These three wires link all the boards in parallel.

Terminals 1, 2 and 3 on connector J9 (A, B, C are connected internally) of the basic board are connected to terminals 1, 2 and 3 of connector J12 of the SCPM boards, terminal J4 of the PD4-EXV board, and terminal J9 of auxiliary boards type 1 or 2 respectively.

Incorrect connection will render the system inoperative.

3.2.5 - Slave board addresses

Every slave board has a unique address controlled by 8 DIP switches. The switch is disabled when it is in the open position (OPEN or OFF). On SCPM boards SIO address switch is labelled 'ADDR'.

NOTE: Any incorrect address will prevent the unit from starting. Turn off the power before amending the address of any auxiliary board.

Board addresses

Board	DIP switch (0 = open)							
	1	2	3	4	5	6	7	8
PD4-EXV	1	0	1	1	1	0	0	0
Auxiliary board type 1 or 2 - # 1	1	0	0	0	1	1	0	0
Auxiliary board type 1 or 2 - # 1	0	0	0	1	1	1	0	0
SCPM # 1 (compressor A1)	0	0	1	0	1	0	1	0
SCPM # 2 (compressor A2)	1	1	1	1	1	0	1	0
SCPM # 3 (compressor B1)	0	1	0	1	0	1	1	0
SCPM # 4 (compressor B2)	1	0	1	0	1	1	1	0

3.2.6 - Power supply to the boards

All boards are supplied by a 24 V source, referred to earth. In the event of a power supply interrupt, the unit restarts automatically without the need for an external command. However, any faults active when the supply is interrupted are saved and may in certain cases prevent a circuit or unit from restarting.

NOTE: When connecting the power supply for the boards, maintain polarity.

3.2.7 - Light emitting diodes on boards

All boards continuously check and indicate the proper operation of their electronic circuits. A light emitting diode (LED) lights on each board when it is operating properly.

Red LED

- The MAIN red LED flashes at about 2 second intervals to show that the module is working properly.
- Irregular flashing or no flashing is a sign of a defective board.

Green LED (item SIO on the board)

- This LED flashes continuously to show that the board is communicating correctly over its internal bus.
- If this LED is not flashing, check the wiring of the SIO bus and the address of the board (slave board only). If the basic board is not linked to any slave boards, this LED should not flash.
- If all slave boards indicate a communication fault, check the SIO bus connection on the basic board. If this connection is correct and the fault persists, replace the basic board.

Orange LED - CCN/clock board

- This LED flashes to show that the basic board is communicating via the CCN bus.

3.3 - The controls

3.3.1 - Electronic expansion valve (EXV)

The EXV is used to adjust the refrigerant flow to changes in the operating conditions of the machine. For this purpose, a series of calibrated orifices are machined into the wall of the refrigerant inlet port. As the refrigerant passes through these orifices, it expands and becomes a bi-phase mixture (liquid and gas).

To adjust the refrigerant flow to changes in operating conditions, a piston moves constantly up or down to vary the cross-section of the refrigerant path. This piston is driven by an electronically controlled linear stepper motor. The high degree of accuracy with which the piston is positioned ensures that the flow of refrigerant is precisely controlled.

NOTE: The external connector of the EXV must be cleaned and coated with silicone grease (Part No. 397 EE) to keep out condensation and prevent corrosion.

3.3.2 - The head pressure controls

The controller can deal with the following:

- in the case of air-cooled units, for each circuit, fan stages together with, if necessary, a variable speed fan (controlled by an auxiliary board type 1)
- in the case of water-cooled units, a water valve. This valve is controlled by an auxiliary board type 1 which supplies a 0-10 V d.c. signal.

3.3.3 - The evaporator pump

In appropriate cases the controller can also regulate an evaporator pump. This facility does not require an additional board.

3.3.4 - The condenser pump

In appropriate cases the controller can also regulate a condenser pump (for water-cooled units). This control does not require an additional board.

3.3.5 - The evaporator heater

The evaporator heater can be regulated by the unit control on air-cooled units to protect the evaporator against frost. This control requires an additional board.

3.3.6 - Pressure sensors

These are used to measure the following pressures in each circuit:

- Discharge gas pressure (high pressure type)
- Suction pressure (low pressure type)
- Oil pressure (high pressure type, except for the low ambient temperature option when the sensor used is a wide-band sensor)
- Economizer pressure (high pressure type)

These electronic sensors deliver 0 to 5 V d.c. The economizer and oil pressure sensors are connected to the SCPM board and, as the others, are measured by the basic board.

Discharge pressure sensors

These are on the high pressure side of each circuit. They replace the usual discharge gas pressure gauges and are used to control head pressure or high pressure load shedding.

Oil pressure sensors

These sensors are located at the oil pressure port of each compressor. The economizer pressure is subtracted from this value to arrive at the differential oil pressure.

Suction pressure sensors

They are located in the high-pressure side of the evaporator, and measure the low-pressure side of each circuit.

Economizer pressure sensors

These sensors measure the intermediate pressure between high and low pressure. They are used to control the oil pressure differential. They are located at the plate heat exchanger outlet (for units equipped with economizers) or on the motor cooling line of each motor.

3.3.7 - Thermistors

These all have similar characteristics.

Evaporator entering and leaving water temperature sensor

The evaporator entering water temperature sensor and the leaving water temperature sensor are installed in the entering and leaving side water box.

Discharge gas sensor

This sensor is used to measure the discharge gas temperature, and permits control of the discharge temperature superheat. It is located in the discharge line of each compressor.

Motor sensor

This is used to control the motor temperature of each compressor. The terminals of this sensor are situated on the compressor terminal board.

Condenser entering and leaving water temperature sensors

These are used to control the heating capacity on heat pumps. In cooling only units they have no control function. They are installed in the common condenser entering and leaving line.

Heat reclaim condenser entering/leaving water temperatures

These sensors measure the entering and leaving water temperatures of heat reclaim condensers and are used on air-cooled units. They may be fitted as options.

Temperature setpoint reset sensor

This is an optional 0-10 V sensor which can be installed remotely from the unit. It is used to reset the cooling and heating setpoint on the unit as a function of either the outdoor air temperature or ambient room temperature. The sensor is not supplied by Carrier, and must be configured in the User Menu.

Outdoor temperature sensor

Mounted on the control box. It is used for start-up, setpoint temperature reset and frost protection control.

Master/slave assembly temperature control

The optional water temperature sensor can be used for master/slave assembly control.

3.4 - User connections

The connections below are available at the customer's terminal block. Some of them can only be used in special operating modes. For further details see the sections that describe the functions (section 5) and the configurations (section 4.2.1).

Connection terminals				
Description	Connector/ channel	Terminal	Description	Remarks
Alarm relay output, circuit A	J3 / CH24	30A - 31A	Indicates alarms in circuit A	Volt-free contacts 24 V a.c. 48 V d.c. max, 20 V a.c. or V d.c., 3 A max, 80 mA min, external power supply. Connector: 6 pin WAGO 231-306/026000 pitch 5.08.
Alarm relay output, circuit B	J3 / CH25	30B - 31B	Indicates alarms in circuit B	
Critical fault relay output	J3 / CH25	37-38	Indicates that the compressor control contactor is stuck closed	
User safety loop and chilled water pump interlock	J4 / CH15a	34 - 35	This contact is mounted in series with the water flow control contact. It can be used for any user safety loop that requires that the unit is shut down, if it is open. The chilled water pump operation auxiliary contact is connected between these two terminals.	24 V a.c., 20 mA Connector: 10 pin WAGO 734-110, pitch 3.5
Remote start/stop	J4 / CH11	32 - 33	The remote start/stop command is only used if the unit is under remote operation control (rEM). See section 4.2.1.	
Remote cooling setpoint selection	J4 / CH12	65 - 66	The remote cooling setpoint selection command is only used if the unit is under remote operation control (rEM). See section 4.2.1.	
Remote heating/cooling control	J4 / CH13	63 - 64	The remote heating/cooling control command is only used if the unit is under remote operation control (rEM). See section 4.2.1.	
or remote heat reclaim control	J4 / CH13	63 - 64	The command allows selection of the second condensing setpoint or of the heat reclaim mode. It is only used if the unit is under remote operation control (rEM). See section 4.2.1.	
Demand limit command	J4 / CH14	73 - 74	This contact permits activating the unit demand limit function. See section 5.8. This contact is active, whatever the operating type.	
0-10 V d.c. setpoint reset or demand limit entry	J8 / CH10	71 - 72	This 0-10 V d.c. input is used for setpoint reset or unit demand limit. It is active, whatever the unit operating type. This 0-10 V signal can be supplied by a user command or a 0-10 V temperature sensor.	Connector: 2 pin WAGO 231-302/026000 pitch 5.08
Connection to CCN	J12	1 - 2 - 3	A RS-485 bus is used for connection to the CCN. The CCN connector is located on the CCN/clock board (inserted on the PD4 BASIC board) - Pin 1: signal + - Pin 2: ground - Pin 3: signal -	Use of a shielded cable (max. length: 1000m). Shielding: braiding on 95%-100% of the cable surface. Shielding connection at the two cable ends.

Available terminals				
Description	Connector/ channel	Terminal	Description	Remarks
Condenser water flow switch input	J5/CH17		This contact is used to detect lack of condenser water flow and shuts down the unit.	24 V a.c. - 20 mA
Evaporator 1 and 2 pump operation input	J5/CH18		This contact is used to detect an evaporator pump operation fault and switches over to the other evaporator pump*.	
Evaporator 1 control	J2/CH19		This contact permits control of evaporator 1 pump by the unit*.	24 V a.c. internal supply. Max. consumption - each output: 20 VA/10 W - for all 3: 40 VA/20 W if all are used
Evaporator 2 control	J2/CH20		This contact permits control of evaporator 2 pump by the unit*.	
Condenser pump control	J2/CH21		This contact permits control of condenser pump by the unit*.	

* Associated functions, if selected: automatic changeover, pump 1 and 2; manual or CCN selection; periodical; by default.

4 - SETTING UP PRO-DIALOG PLUS CONTROL

4.1 - Local interface general features

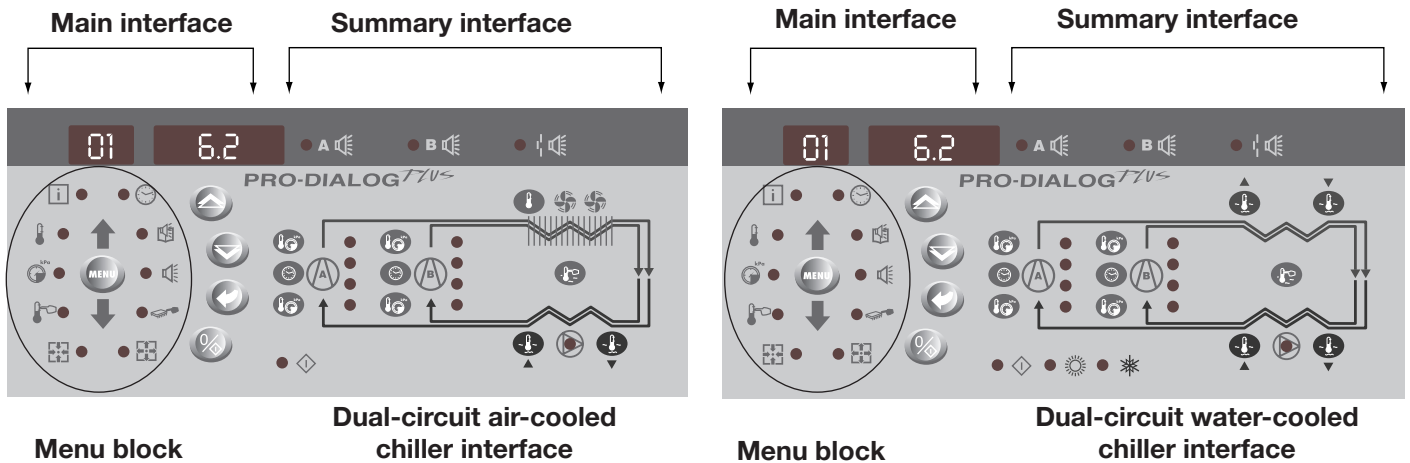

The local interface enables a number of operating parameters to be displayed and modified.

The interface consists of two distinct parts: the main interface (left hand section) and the summary interface (right hand section).

Main interface

It gives access to all PRO-DIALOG PLUS data and operating functions. It consists of:

- A two-digit display showing the number of the item selected.
- A four-digit display showing the contents of the item selected.
- LEDs and buttons for unit start/stop, menu selection, menu item selection and value adjustment.

MAIN INTERFACE

BUTTON NAME	DESCRIPTION
MENU	Permits the selection of a main menu. Each main menu is represented by an icon. The icon is lit if active.
Up arrow	Permits scrolling through the menu items (in the two-digit display). If the modification mode is active this button authorises increase of the value of any parameter.
Down arrow	Permits scrolling through the menu items (in the two-digit display). If the modification mode is active this button authorises decrease of the value of any parameter.
Enter	Gives access to the modification mode, validates a modification or displays expanded item description.
Start/stop	Authorises start or stop of the chiller in local mode or modification of its operating type.

MAIN INTERFACE MENU LEDS

LED	NAME	DESCRIPTION
	INFORMATION menu	Displays the general operating parameters for the unit.
	TEMPERATURES menu	Displays the unit operating temperatures.
kPa	PRESSURES menu	Displays the unit operating pressures.
	SETPOINTS menu	Displays the unit setpoints and enables them to be modified.
	INPUTS menu	Displays the status of the unit digital and analogue inputs.
	OUTPUTS/TESTS menu	Displays the status of the unit outputs and enables them to be tested.
	CONFIGURATIONS menu	Displays the unit configuration and enables it to be modified.
	ALARMS menu	Displays active alarms.
	ALARMS HISTORY menu	Displays the history of the alarms.
	OPERATING LOG menu	Displays the operating times and number of starts for the unit and the compressors.

The summary interface (right hand section) includes a mimic diagram of the unit, together with push-buttons and LEDs. It gives quick access to the main operating parameters of the unit.

SUMMARY INTERFACE LEDES

LED	INDICATION WHEN LIT
	Green LED: The unit is authorised to start or is already running
	Red LED: - Lit: circuit A or unit shut down by alarm - Flashing: circuit A or unit running with alarm present
	Red LED: - Lit: circuit B or unit shut down by alarm - Flashing: circuit B or unit running with alarm present
	Red LED: Water flow switch default or user safety lock open.
	Green LED: The evaporator pump is running.
	Yellow LEDs: From top to bottom - start/stop status of compressor A1 and A2 or B1 and B2. Flashing LED indicates that the circuit is in the protection or defrost mode (A or B).
	Green LED: The unit operates in heating mode.
	Green LED: The unit operates in cooling mode.

SUMMARY INTERFACE PUSH BUTTONS

BUTTON	DISPLAY
	Blue button: evaporator leaving or entering water temperature in °C Gray button: outdoor air temperature in °C
	Control point (setpoint + reset) in °C
	Press 1: circuit A/B discharge pressure in kPa Press 2: circuit A/B saturated condensing temperature in °C
	Press 1: circuit A/B suction pressure in kPa Press 2: circuit A/B saturated suction temperature in °C
	Press 1: compressor A1/B1 operating hours in h/10 or h/100 Press 2: compressor A2/B2 operating hours in h/10 or h/100

4.2 - Unit start/stop control

4.2.1 - Description

The unit start/stop can be controlled by one of the following methods:

- Locally on the actual unit (Local control type)
- By remote control with the aid of user contacts (remote control type)
- By CCN control with the aid of the CCN (CCN control type)

The main interface includes a Start/Stop button which can be used to stop or start the unit in the local operating type or to select the remote or CCN operating type.

The available operating types are described in the following table.

The following operating types can be selected using the Start/Stop button:

OPERATING TYPES

4-DIGIT DISPLAY	DESCRIPTION
LOFF	Local Off. The unit is halted in local mode.
L-On	Local On. The unit is in local control mode and is authorised to start.
L-Sc*	Local On - timer control. The unit is in local control mode. It is authorised to start if the period is occupied. If the timer program for unit operation is unoccupied, the unit remains shut down until the period next becomes occupied.
CCN*	CCN. The unit is controlled by CCN commands.
rEM*	Remote. The unit is controlled by remote control contacts.
MAST*	Master Unit. The unit runs as a master in a two unit lead/lag arrangement. This is displayed if the unit is configured for master/slave control. See section 5.21.

* Displayed if the configuration requires it. Section 5.1 gives a more detailed description of the commands to start/stop the unit, analysed by operating type.

4.2.2 - Stopping the unit in local mode

The unit can be stopped in local mode at any time by pressing the Start/Stop button.

TO STOP THE UNIT

BUTTON	ACTION	2-DIGIT DISPLAY	4-DIGIT DISPLAY
	Press the Start/Stop button for less than 4 seconds (one short press is enough).	C	LOFF
	If the button is released, the unit stops without the need for further action.	t	LOFF

4.2.3 - Starting unit and selecting an operating type

The unit can be started in local mode, or unit operating type can be changed at any time using the Start/Stop button. In the example that follows, the unit is stopped (LOFF) and the user wants to start the unit in local mode.

CHANGING THE OPERATING TYPE

BUTTON	ACTION	2-DIGIT DISPLAY	4-DIGIT DISPLAY
	Continually press the operating type selection button for more than 4 seconds.	C	LOFF
	Hold down the Start/Stop button. The available operating types are displayed one by one until the button is released.		L-On L-Sc ↓ rEM ↑
	Release the Start/Stop button if the operating type you want is displayed (in this example L-On). "C" flashes in the 2-digit display to show that the controller is awaiting confirmation.		L-On
	Press the Enter button to confirm the operating type selected (in this example: L-On). "t" is displayed in the 2-digit display to indicate the operating type selected. If the Enter button is not pressed soon enough, the controller will cancel the change and continue to use the previous operating type.	t	L-On

4.3 - Menus

4.3.1 - Selecting a menu

The MENU button authorises you to select a menu from the 10 main menus that are available. Each time you press this button one of the 10 LEDs lights up in turn alongside each of the icons representing a main menu. The active menu is the one against which the LED is lit. If a menu is empty then its LED is not lit. To scroll quickly through the menus, hold the MENU button down.

4.3.2 - Selecting a menu item

The up and down Arrow buttons let you scroll through the menu items. Menu item numbers are displayed in the two-digit display. The item number increases or decreases every time you press the up or down Arrow button. The menu items that are not in use or incompatible with the configuration are not displayed. The value or status associated with the active item is displayed in the four-digit display. To scroll quickly through the items, hold the up or down Arrow button down.

The following example shows how to access item 3 in the Pressures menu.

SELECTING A MENU ITEM

OPERATION	PRESS BUTTON	MENU LED	ITEM NUMBER 2-DIGIT DISPLAY
Press the MENU button until the LED marked PRESSURE lights.			0
			0
Press one of the Arrow buttons until the two-digit display shows 3 (item number 3).			1
			2
			3

4.3.3 - Modifying the value of a parameter/access to a sub-menu

Press the Enter button for more than 2 seconds to enter the modification mode or to select a sub-menu. This lets you correct the value of an item or select a sub-menu with the aid of the up and down Arrow buttons (if you are authorised to overwrite the item concerned). When modification mode is activated, the LED for the main menu to which the item belongs flashes in menu block. Once the required value is obtained, press the Enter button again to validate the change or to access the sub-menu. The LED for the menu to which the item belongs then stops flashing, indicating that modification mode no longer applies.

In modification mode, the value to be modified increases or decreases in steps of 0.1 every time you press the Arrow buttons. Holding one of these buttons down increases the rate of increase or decrease.

NOTE: The access to a sub-menu may require entering a password. This is automatically requested. See section 4.5.7.2.

The example below shows how to modify the value of item 1 in the Setpoint menu.

MODIFYING THE VALUE OF A PARAMETER

OPERATION	PRESS button	MENU LED	ITEM NUMBER 2-DIGIT DISPLAY	ITEM NUMBER 4-DIGIT DISPLAY
Hold on the MENU button until the LED for SETPOINT lights.			0	
			0	
Press one of the Arrow buttons until the two-digit display shows 1 (item number 1 - cooling setpoint 2). The value for setpoint 2 is displayed in the four-digit display (6.0°C in this example).			1	
			1	6.0
Press the Enter button for more than 2 seconds to enable the value associated with item 1 to be modified. The Setpoint menu LED flashes indicating that modification mode is active.			1	6.0
	Keep pressing the Down Arrow button until the value 5.7 is displayed in the four-digit display. The Setpoint menu LED keeps flashing.			1
			1	5.8
			1	5.7
Press the Enter button again to validate the change. The new setpoint is 5.7°C. The Setpoint menu LED stops flashing, indicating that modification mode no longer applies.			1	5.7

4.3.4 - Expand display

Pressing the Enter button causes a 23 character text expansion to be scrolled across the four-digit display. All user menus provide an expansion of the current displayed parameters. If the expansion is complete the four-digit display reverts to item value. This function can be inhibited through the User Configuration menu.

4.4 - General menu structure

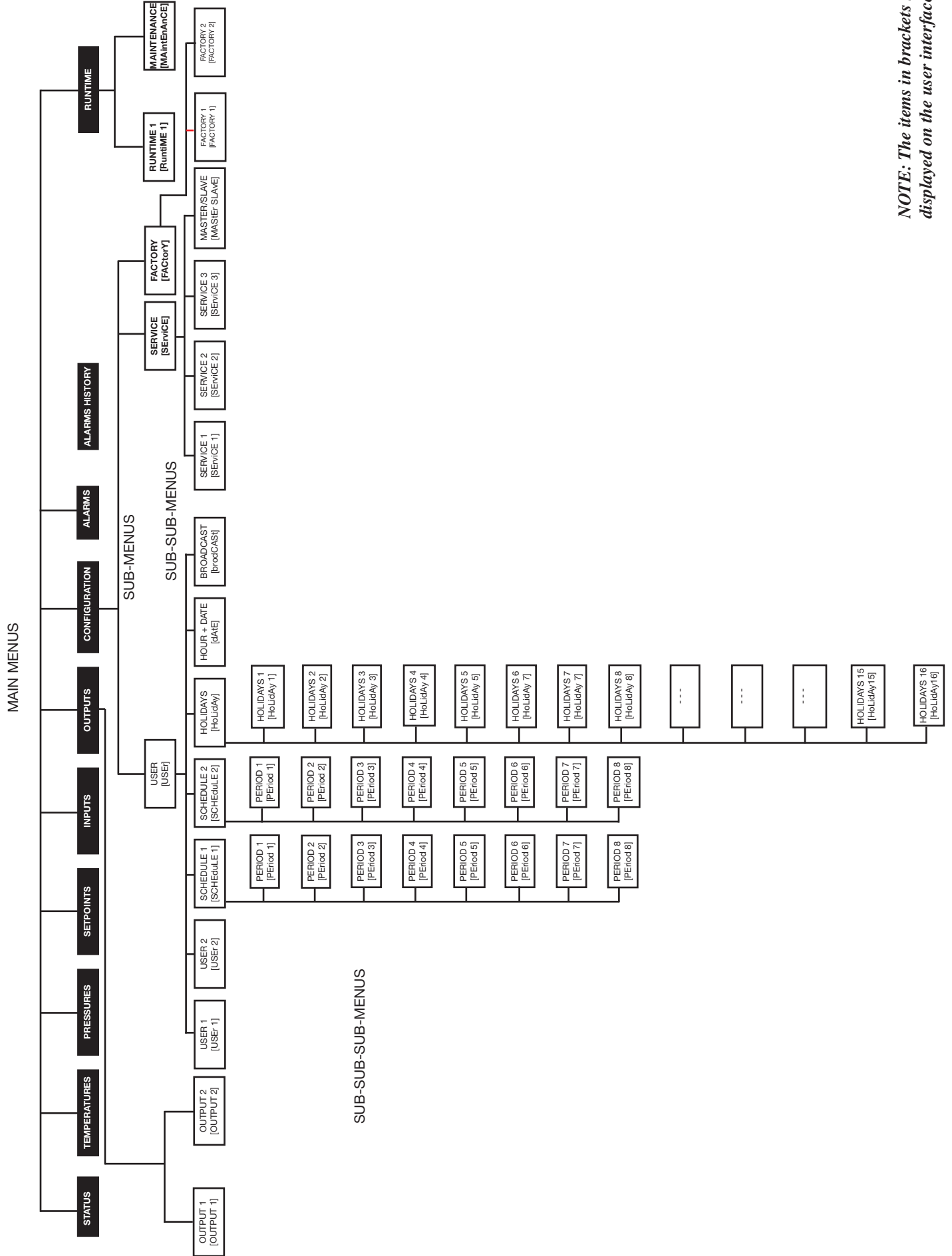

NOTE: The items in brackets show what is displayed on the user interface.

4.5 - Menu tree structure

ITEM	STATUS	TEMP	PRESSURES	SETPOINTS	INPUTS	OUTPUTS	CONFIG	ALARMS	ALARMS HIST	RUNTIMES
0	Default display	Evaporator water entering temp.	Discharge pressure, circuit A	Cooling setpoint 1	Contact 1: remote on/off	SUB-MENU: Outputs 1 [OUTPUTS1]	SUB-MENU: User Configuration [USER]	Number of active alarms/resets	Historic alarm code 1	SUB-MENU: Runtimes
1	Active modes	Evaporator water leaving temp.	Suction pressure, circuit A	Cooling setpoint 2	Contact 2: remote setpoint	SUB-MENU: Outputs 2 [OUTPUTS2]	SUB-MENU: Service Configuration [SERVICE]	Active alarm code 1**	Historic alarm code 2	SUB-MENU: Maintenance
2	Chiller occupied/unoccupied	Condenser water entering temperature	Oil pressure, compressor A1	Heating setpoint	Contact 3: remote heating/cooling	-	SUB-MENU: Factory Configuration [FACTORY]	Active alarm code 2**	Historic alarm code 3	-
3	Minutes left	Condenser water leaving temperature	Oil pressure, compressor A2	Condensing setpoint	Contact 4: remote heat reclaim operation	-	-	Active alarm code 3**	Historic alarm code 4	-
4	Cooling/heating selection	Heat reclaim water entering temperature	Oil differential pressure, compressor A1	Heat reclaim setpoint	Demand limit selection	-	-	Active alarm code 4**	Historic alarm code 5	-
5	Heat reclaim selection	Heat reclaim water leaving temperature	Oil differential pressure, compressor A2	Demand limit setpoint in %	Water flow control and customer interlock	-	-	Active alarm code 5**	Historic alarm code 6	-
6	Unit capacity in %	Saturated discharge temperature, circuit A	Economizer A1 pressure	Cooling mode ramp	Evaporator pump fault detection	-	-	-	Historic alarm code 7	-
7	Capacity circuit A in %	Saturated suction temperature, circuit A	Economizer A2 pressure	Heating mode ramp	Water flow control, condenser	-	-	-	Historic alarm code 8	-
8	Capacity circuit B in %	Gas discharge temperature, circuit A	Discharge pressure, circuit B	Cooling - threshold for zero reset	Control box thermostat and phase reversal interlock control	-	-	-	Historic alarm code 9	-
9	Present demand limit in %	Discharge superheat, circuit A	Suction pressure, circuit B	Cooling - threshold for max. reset	Oil level, circuit A	-	-	-	Historic alarm code 10	-
10	Present lag limit in %	Temperature motor A1	Oil pressure, compressor B1	Cooling - max. reset value	Oil level, circuit B	-	-	-	-	-
11	Setpoint in local control	Temperature motor A2	Oil pressure, compressor B2	Heating - threshold for zero reset	External 0-10 V d.c. signal	-	-	-	-	-
12	Setpoint occupied/unoccupied mode	Saturated discharge temperature, circuit B	Oil differential pressure, compressor B1	Heating - threshold for max. reset	Compressor current A1	-	-	-	-	-
13	Active setpoint	Saturated suction temperature, circuit B	Oil differential pressure, compressor B2	Heating - max. reset value	Compressor current A2	-	-	-	-	-
14	Control point	Gas discharge temperature, circuit B	Economizer B1 pressure	-	Compressor current B1	-	-	-	-	-
15	Controlled water temperature	Discharge superheat, circuit B	Economizer B2 pressure	-	Compressor current B2	-	-	-	-	-
16	Condensing point	Temperature motor B1	Remote discharge pressure, circuit A	-	Total compressor operating current	-	-	-	-	-
17	Heat reclaim indicator, circuit A	Temperature motor B2	Remote discharge pressure, circuit B	-	-	-	-	-	-	-
18	Heat reclaim indicator, circuit B	Outdoor temperature	Heat reclaim pressure, circuit A	-	-	-	-	-	-	-
19	-	Water loop temperature, master/slave assembly	Heat reclaim pressure, circuit B	-	-	-	-	-	-	-

*** Displayed if the alarm exists
- Not in use

NOTE: The items in brackets show what is displayed on the user interface.

4.5.1 - Description of the Information menu

INFORMATION MENU (3)

ITEM	FORMAT	UNITS	DESCRIPTION
0			Automatic display mode. It cycles through the following displays:
	±nn.n	°C	1: Controlled water temperature: temperature of the water that the unit tries to maintain at the control point.
	LOFF	-	2: Unit operating type Local Off
	L-On	-	Local On
	L-Sc	-	Local On - based on unit clock.
	CCn	-	CCN Control.
	rEM	-	Remote Control
	MASt	-	Master unit
	OFF	-	3: Unit status Off: Unit is stopped and not authorised to start.
	rEADY	-	Ready: Unit is authorised to start
	dELAY	-	Delay: Unit is in delay at start-up. This delay is active after the unit has been switched on. The delay can be configured in the User Configuration menu.
	STOPPing	-	Stopping: Unit is currently stopping.
	running	-	On: Unit is running or authorised to start.
	triPout	-	Fault shutdown.
	OVErridE	-	Limit: The operating conditions do not allow total unit operation.
	OCCUPIEd	-	4. Unit occupied/unoccupied status Occupied: Unit in occupied mode
	UNOCCUPIEd	-	Unoccupied: Unit in unoccupied mode
	COOL	-	5. Heating/cooling operating mode Cooling: Unit operates in cooling mode
	HEAT	-	Heating: Unit operates in heating mode
	rECLAIM	-	Cooling: Unit is in auto cooling and heat reclaim demand is active
	ALARm	-	6. Alarm mode Alarm: Unit is totally stopped because of failure.
	ALERt	-	Alert: Unit is in failure but not completely stopped.
	MAStEr	-	7. Master/Slave status Master: The master/slave control is active and the unit is the master
	SLAvE	-	Slave: The master/slave control is active and the unit is the slave
1 [1]	nn	-	Active mode codes. Each active mode is displayed in turn. This Item is masked when nil. Pressing the enter button when a mode code is displayed causes a character text expansion to be scrolled across the four-digit display. See the description in the following table
2 [2]	occu unoc Forc	-	This item indicates the current chiller occupied/unoccupied mode. Occupied Unoccupied The value is displayed in turn with 'Forc' when the unit is in CCN control and if this variable if forced through CCN.
3	nn.n	minutes	Start-up delay. This item indicates the minutes left before the unit can be started. This delay at start-up is always active after the unit has been switched on. The delay can be configured in the User Configuration 1 menu.
4 [2]	HEAT COOL	-	Heating/cooling on selection: This item is accessible in read/write, if the unit is in local control mode. It is only displayed, if the unit is in LOFF, L-On or L-Sc operating type. Displayed for heat pumps. Heating mode selection Cooling mode selection
5 [2]	YES NO	-	Heat reclaim mode selection: This item is accessible in read/write, if the unit is in local control mode. It is only displayed, if the unit is in LOFF, L-On or L-Sc operating type. Displayed for air-cooled or water-cooled units with a condenser water valve. Heat reclaim mode selection, use of heat reclaim condensing setpoint. Normal cooling mode selection, use of standard condensing setpoint
6	Nnn	%	Total active capacity of unit.
7	nnn	%	Total active capacity of circuit A.
8 [2]	nnn	%	Total active capacity of circuit B.
9 [2]	nnn Forc	%	Present demand limit. This is the authorised operating capacity of the unit. See section 5.8. The value is displayed in turn with 'Forc' when the unit is in CCN control and if this variable if forced through CCN.
10	nnn	%	Present lag chiller demand limit. Displayed when the master/slave control is selected.
11 [2]	SP-1 SP-2 AUtO	-	Setpoint select in local mode. This point is read/write accessible. Displayed only when the unit is LOFF, L-On or L-Sc operating type. SP-1 = cooling setpoint 1 SP-2 = cooling setpoint 2 AUtO = active setpoint depends on schedule 2 (setpoint selection schedule). See section 5.7.1 & 4.5.7.6.
12 [2]	occu unoc Forc	-	Setpoint occupied mode. Occupied: cooling setpoint 1 is active Unoccupied: cooling setpoint 2 is active The value shall be displayed in turn with 'Forc' when the unit is in CCN control and if this variable if forced through CCN.
13	±nn.n	°C	Active setpoint. This is the current cooling/heating setpoint: it refers to cooling/heating setpoint 1 or 2.
14	±nn.n Forc	°C	Control point. This is the setpoint used by the controller to adjust the temperature of the leaving or entering water (according to configuration). Control point = active setpoint + reset. See section 5.7 The value is displayed in turn with 'Forc' when the unit is in CCN control and if this variable if forced through CCN.
15	±nn.n	°C	Controlled water temperature. Water temperature that the unit tries to maintain at the control point.
16	±nn.n Forc	°C	Condensing setpoint. The value is displayed in turn with 'Forc' if the unit is in CCN mode and this parameter is forced by CCN.
17	n		Heat reclaim function indicator, circuit A (see heat reclaim section)
18	n		Heat reclaim function indicator, circuit B (see heat reclaim section)

Legend

- 1 This item is masked when nil.
- 2 This item is displayed in certain unit configurations only.
- 3 Access to this menu is read-only except for item 10 that can be forced when the unit is in Local operating type.

DESCRIPTION OF OPERATING MODES (ITEM 1 OF THE INFORMATION MENU)

MODE #	MODE NAME	DESCRIPTION
7	Delay at start-up active	The delay at start-up operates after the unit has been switched on. If the delay has not expired, the mode is active. The delay is configured in the User1 configuration menu.
8	2nd cooling setpoint active	The second cooling setpoint is active. See section 5.7.1
9	Setpoint reset active	In this mode, the unit uses the reset function to adjust the leaving or entering water temperature setpoint. See section 5.7.2.
10	Demand limit active	In this mode, the capacity at which the unit is allowed to operate is limited. See section 5.8.
11	Ramp loading active	Ramp loading is active. In this mode, the controlled high or low water temperature value (in °C/min) in heating mode is limited to a preset value in order to prevent compressor overload. The ramp function must be configured (see User1 configuration menu). The ramp values can be modified (see setpoint menu).
12	Low entering water temperature protection in heating mode	The unit is in heating mode and the temperature of the evaporator leaving water is lower than the lesser of the two cooling setpoints. A capacity stage is removed. This mode only applies to heat pumps.
13,14	Low suction temperature protection	13 = circuit A & 14 = circuit B. Protection for evaporator suction low temperature circuit is active. In this mode, circuit capacity is not authorised to rise if the unit is in cooling mode, and saturated suction temperature in the circuit is lower than the frost protection threshold.
15,16	Low discharge superheat protection	15 = circuit A & 16 = circuit B. In this mode the circuit capacity is not authorised to rise.
17,18	High pressure protection	17 = circuit A & 18 = circuit B. The circuit is in high pressure protection mode because the HP protection threshold has been exceeded. The circuit capacity is not authorised to rise and any slave compressor can be stopped in order to prevent a high pressure break.
19,20	High current protection	19 = circuit A & 20 = circuit B. Circuit capacity is not allowed to rise, as the compressor has reached the high current protection threshold and could be shut down.
21	Heat reclaim active	Circuit A or circuit B operates in heat reclaim mode and not in standard cooling mode (pumpdown phase is activated).
22	Evaporator heater active	Mode active if risk of frost exists.
23	Evaporator pump reversal active	Two evaporator water pumps installed on the unit and pump reversal is active. See section 5.3
24	Periodic evaporator pump start-up	The unit is shut down and is started every day at 14:00 hours for 2 seconds. This function must be configured in the User1 menu. See sections 5.3 and 4.5.7.3.
25	Low night-time capacity	Unit capacity is limited. The period when this mode starts, as well as the limited capacity in night-time mode are controlled in Costomer 1 menu.
26	Unit under SM control	Unit is under control of a System Manager (FSM or CSM III).
27	Master/slave link active	Unit is connected to a secondary unit by a master slave link and either: - the unit is configured as a master and this master is operating, or - the unit is configured as a slave and this slave is operating.

4.5.2 - Description of the Temperatures menu

TEMPERATURES MENU [2]

ITEM	FORMAT	UNITS	COMMENTS
0	±nn.n	°C	Evaporator entering water temperature
1	±nn.n	°C	Evaporator leaving water temperature
2[1]	±nn.n	°C	Condenser entering water temperature
3[1]	±nn.n	°C	Condenser leaving water temperature
4[1]	±nn.n	°C	Reclaim condenser entering water temperature
5[1]	±nn.n	°C	Reclaim condenser leaving water temperature
6	±nn.n	°C	Saturated discharge temperature circuit A
7	±nn.n	°C	Saturated suction temperature circuit A
8	±nn.n	°C	Discharge gas temperature circuit A
9	±nn.n	°C	Discharge superheat temperature circuit A
10	±nn.n	°C	Motor temperature A1
11[1]	±nn.n	°C	Motor temperature A2
12	±nn.n	°C	Saturated discharge temperature circuit B
13	±nn.n	°C	Saturated suction temperature circuit B
14	±nn.n	°C	Discharge gas temperature circuit B
15	±nn.n	°C	Discharge superheat temperature circuit B
16	±nn.n	°C	Motor temperature B1
17[1]	±nn.n	°C	Motor temperature B2
18	±nn.n	°C	Outdoor temperature
19[1]	±nn.n	°C	Water loop temperature, master/slave assembly

Legend

- 1 This item is displayed in certain unit configurations only
- 2 Access to this menu is read-only.

4.5.3 - Description of the Pressures menu

PRESSURES MENU [2]

ITEM	FORMAT	UNITS	COMMENTS
0	nxxx	kPa	Discharge pressure circuit A
1	nxxx	kPa	Suction pressure circuit A
2	nxxx	kPa	Oil pressure compressor A1
3[1]	nxxx	kPa	Oil pressure compressor A2
4	nxxx	kPa	Differential oil pressure compressor A1
5[1]	nxxx	kPa	Differential oil pressure compressor A2
6	nxxx	kPa	Economizer pressure A1
7[1]	nxxx	kPa	Economizer pressure A2
8	nxxx	kPa	Discharge pressure circuit B
9	nxxx	kPa	Suction pressure circuit B
10	nxxx	kPa	Oil pressure compressor B1
11[1]	nxxx	kPa	Oil pressure compressor B2
12	nxxx	kPa	Differential oil pressure compressor B1
13[1]	nxxx	kPa	Differential oil pressure compressor B2
14	nxxx	kPa	Economizer pressure B1
15[1]	nxxx	kPa	Economizer pressure B2
16[1]	nxxx	kPa	Remote discharge pressure, circuit A
17[1]	nxxx	kPa	Remote discharge pressure, circuit B
18[1]	nxxx	kPa	Pumpdown pressure, heat reclaim, circuit A
19[1]	nxxx	kPa	Pumpdown pressure, heat reclaim, circuit B

Legend

- 1 This item is displayed in certain unit configurations only.
- 2 Access to this menu is read-only

4.5.4 - Description of the Setpoints menu

SETPOINTS MENU [2]

ITEM	FORMAT	UNITS	RANGE	COMMENTS
0	±nn.n	°C	See table below	This item lets you display and modify Cooling setpoint 1*
1	±nn.n	°C	See table below	This item lets you display and modify Cooling setpoint 2*
2	nnn	°C	See table below	This item lets you display and modify Heating setpoint* , only displayed for heat pumps.
3 [1]	nnn	°C	See table below	This item lets you display and modify the condensing setpoint*. It is used by the control to regulate the fan stages or a variable-speed fan (air-cooled units) or the condenser water valve control (water-cooled units), if the unit is not in heat reclaim mode.
4 [1]	nnn	°C	See table below	This item lets you display and modify the heat reclaim setpoint*. As item 3, this is used for condensing setpoint control.
5	nnn	%	0 to 100	Capacity limit setpoint. Limitation by volt-free contact. This item is used to define the maximum capacity that the unit is authorised to use, if the capacity limit contact activate the limit. See section 5.8.
6 [1]	±nn.n	°C/min	0.1 to 1.1	Cooling ramp loading rate. This parameter is only accessible if the ramp function is validated in the User Configuration 1 menu. This item refers to the maximum rate of temperature rise in °C in the water heat exchanger in cooling mode. When capacity loading is effectively limited by the ramp, mode 11 is active.
7 [1]	±nn.n	°C/min	0.1 to 1.1	Heating ramp loading rate. This parameter is only accessible if the ramp function is validated in the User Configuration 1 menu. This item refers to the maximum rate of temperature drop in °C in the water heat exchanger in heating mode. When capacity loading is effectively limited by the ramp, mode 11 is active.
8 [1]	±nn.n	[3]	See table below	Zero reset threshold, cooling mode**
9 [1]	±nn.n	[3]	See table below	Full reset threshold, cooling mode**
10 [1]	±nn.n	°C	See table below	Full reset value, cooling mode**
11 [1]	±nn.n	[3]	See table below	Zero reset threshold, heating mode**
12 [1]	±nn.n	[3]	See table below	Full reset threshold, heating mode**
13 [1]	±nn.n	°C	-16 to 16	Full reset value, heating mode**

Legend

1 This item is displayed in certain unit configurations only.

2 All points contained in this table can be modified.

* Those setpoints can be used for entering or leaving water temperature control. By default the unit controls the evaporator entering fluid temperature. Leaving fluid temperature control requires a parameter modification in the Service Configuration menu.

** These parameters are only accessible when reset based on OAT or delta T has been selected in the User Configuration 1 menu. See section 4.5.7.3.

SETPOINT	DESCRIPTION	CONTROL FOR LEAVING WATER	CONTROL FOR ENTERING WATER
Cooling	Minimum setpoint		
	- Water	3.3°C	9.3°C
	- Medium Brine	-10°C	-4°C
	- Low Brine	-20°C	-14°C
	Maximum setpoint		
Heating*	Maximum setpoint	MCT - 4.0 K	MCT - 10.0 K

Note:

Three setpoint reset configuration modes can be selected in the Customer 1 menu:

1 Reset using an external 0-10 V d.c. signal

2 Reset using Delta T

3 Reset by external temperature sensor (air-cooled units only)

The items with zero reset or maximum reset are based on these three modes.

* MCT = Maximum Condensing Temperature (depending on the application)

4.5.5 - Description of the Inputs menu

INPUTS MENU [2]

ITEM	FORMAT	UNITS	COMMENTS
0	OPEn/CLoS	-	Remote contact 1 status This contact is used to start (contact closed) and stop (contact open) the chiller. It is only valid, if the unit is in the remote operating control (rEM) mode.
1	OPEn/CLoS	-	Remote contact 2 status This contact is used to select a cooling only setpoint, if the unit is in cooling mode and in the remote operating control (rEM) type. Contact open = csp1 Contact closed = csp2
2[1]	OPEn/CLoS	-	Remote contact 3 status This contact is used to select the heating or cooling mode, only if the unit is in the remote operating control type. Contact open: unit in cooling mode Contact closed: unit in heating mode
3[3]	OPEn/CLoS	-	Remote contact 4 status This contact is used to select the second condensing setpoint or the heat reclaim mode (for a heat reclaim unit), only if the unit is in the remote operating control type. Contact open = unit uses the normal condensing setpoint and is in normal mode (no heat reclaim) Contact closed = unit uses the heat reclaim setpoint and is in heat reclaim mode.
4	OPEn/CLoS	-	Remote contact 5 status* If this contact is closed, it permits limiting the unit demand, based on the demand limit setpoint, if the demand limit method by contact has been selected.
5	OPEn/CLoS	-	Water flow contact status* and customer interlock control Opening of this contact shuts the unit off or prevents its start-up and generates an alarm. It is used to control the water circulation.
6[1]	OPEn/CLoS	-	Water pump operation status. If the contact opens when the evaporator pump has received a command to operate, this trips a pump failure alarm.
7[1]	OPEn/CLoS	-	Condenser water flow control. Controls the condenser water circulation.
8[1]	OPEn/CLoS	-	Control box thermostat and phase reversal interlock status. Opening of this contact shuts the unit off or prevents its start-up and generates an alarm.
9	OPEn/CLoS	-	Oil level, circuit A
10	OPEn/CLoS	-	Oil level, circuit B
11	0 - 10	Volts	External signal
12	nnn	Amp.	Compressor A1 current
13[1]	nnn	Amp.	Compressor A2 current
14[1]	nnn	Amp.	Compressor B1 current
15[1]	nnn	Amp.	Compressor B2 current
16	nnnn	Amp.	Total compressor operating current

Legend

1 This item is displayed in certain unit configurations only

2 Access to this menu is read-only

* Active in all operating types

See section 3.4

4.5.6 - Description of the Outputs/Tests menu

4.5.6.1 - General

This menu displays the status of the controller outputs. Moreover, when the machine is fully stopped (LOFF) the outputs can be activated for manual or automatic tests (the access to the tests is password controlled).

4.5.6.2 - Menu description

OUTPUTS STATUS AND TESTS MENU [2] [3]

ITEM	FORMAT	UNITS	DESCRIPTION
0			This item returns you to the previous menu.
1		- - - -	Compressor status b1 = compressor A1 b2 = compressor A2 b3 = compressor B1 b4 = compressor B2 The compressor status cannot be forced
2 [1]		- - - -	Loader status b1 = loader 1 circuit A b2 = loader 2 circuit A b3 = loader 1 circuit B b4 = loader 2 circuit B This item permits display of the loader status in circuits A or B. It also permits independent testing. In test mode the direction arrows permit successive display of 0001, 0010, 0100 and 1000, so as to in turn force authorisation of each output.
3 [1]	tEST	- - - -	Motor cooling valve status/test circuit A b1 = main valve compressor A1 b2 = additional valve or economizer compressor A1 b3 = main valve compressor A2 b4 = additional valve or economizer compressor A2 This item permits display of the motor cooling valve status in circuit A. It also permits independent testing. In test mode the direction arrows permit successive display of 0001, 0010, 0100 and 1000, so as to in turn force authorisation of each output.
4 [1]	tEST	- - - -	Motor cooling valve status/test circuit B b1 = main valve compressor B1 b2 = additional valve or economizer compressor B1 b3 = main valve compressor B2 b4 = additional valve or economizer compressor B2 This item permits display of the motor cooling valve status in circuit B. It also permits independent testing. In test mode the direction arrows permit successive display of 0001, 0010, 0100 and 1000, so as to in turn force authorisation of each output.
5	tEST	%	Motor cooling valve cycle status/test, circuit A Only for units with economizer
6	tEST	%	Motor cooling valve cycle status/test, circuit B Only for units with economizer
7	tEST	- - - -	Oil solenoid valve status/test b1 = oil solenoid valve compressor A1 b2 = oil solenoid valve compressor A2 b3 = oil solenoid valve compressor B1 b4 = oil solenoid valve compressor B2 This item permits display of the different compressor valves. It also permits independent testing. In test mode the direction arrows permit successive display of 0001, 0010, 0100 and 1000, so as to in turn force authorisation of each output.
8	tEST	- -	Refrigerant shut-off valve status/test Only for units with evaporator heater b1 = Shut-off valve, circuit A b2 = Shut-off valve, circuit B In test mode the direction arrows permit successive display of 01 and 10, so as to in turn force authorisation of each heater output.
9	tEST	- -	Oil heater output status/test, circuits A and B b1 = oil heater, circuit A b2 = oil heater, circuit B In test mode the direction arrows permit successive display of 01 and 10, so as to in turn force authorisation of each heater output.
10	tEST	-	Oil pump output status/test, circuits A and B b1 = oil pump, circuit A b2 = oil pump, circuit B In test mode the direction arrows permit successive display of 01 and 10, so as to in turn force authorisation of each oil pump output.

Legend

- 1 This item is displayed in certain unit configurations only
- 2 A test is only possible if the units are in local off mode and if all compressors have stopped
- 3 The password is only valid for the test. 'Test' is displayed during the test, alternating with the item number

OUTPUTS STATUS 2 AND TESTS MENU [2] [3]

ITEM	FORMAT	UNITS	DESCRIPTION
0			This item returns you to the previous menu.
1 [1]	tEst	0 - 8	Fan contactor status/test, circuit A This item permits display of the number of fan stages. It also permits them to be tested in a sequentially. In test mode the direction arrows permit successive display from 0 to 8, so as to authorise the forcing the outputs.
2 [1]	tEst	0 - 8	Fan contactor status/test, circuit B This item permits display of the number of fan stages. It also permits them to be tested in a sequentially. In test mode the direction arrows permit successive display from 0 to 8, so as to authorise the forcing the outputs.
3	tEst	- -	Alarm command status/test b1 = alarm circuit A b2 = alarm circuit B In test mode the direction arrows permit successive display of 01 and 10, so as to in turn force authorisation of each alarm output.
4	tEst	%	EXV position, circuit A In the test mode the direction arrows permit forcing the valve to its fully open position.
5	tEst	%	EXV position, circuit B In the test mode the direction arrows permit forcing the valve to its fully open position.
6 [1]	tEst	%	Variable speed fan, circuit A or condenser water valve position in %
7 [1]	tEst	%	Variable speed fan, circuit B or condenser water valve position in %
8	On Stop tEst FAIL Good Forc	- - - - - -	Evaporator water pump No. 1 command status. Not displayed if unit does not control a pump. On: the pump operates Stop: the pump has stopped Forc: This item is only displayed if the unit is in local off mode (LOFF). Selecting this item permits energising the pump without delay and for an unlimited period. The pump continues to operate, until any key on the user interface is pressed: it is then immediately switched off. If the unit is in CCN control mode, the pump status is displayed alternately with 'Forc' if its status is forced by CCN. During the test phase, pump supply is energised for 10 seconds only. When the test has finished, the following display appears: - Fail: displayed if the test has failed, because the pump is not started - Good: displayed if the test succeeds
9	On OFF tEst FAIL Good Forc	- - - - - -	Evaporator water pump No. 2 command status. Not displayed if unit does not control a pump. On: the pump operates Stop: the pump has stopped Forc: This item is only displayed if the unit is in local off mode (LOFF). Selecting this item permits energising the pump without delay and for an unlimited period. The pump continues to operate, until any key on the user interface is pressed: it is then immediately switched off. If the unit is in CCN control mode, the pump status is displayed alternately with 'Forc' if its status is forced by CCN. During the test phase, pump supply is energised for 10 seconds only. When the test has finished, the following display appears: - Fail: displayed if the test has failed, because the pump is not started - Good: displayed if the test succeeds
10	On OFF tEst FAIL Good Forc	- - - - - -	Condenser pump status/test On: the pump operates Stop: the pump has stopped Forc: This item is only displayed if the unit is in local off mode (LOFF). Selecting this item permits energising the pump without delay and for an unlimited period. The pump continues to operate, until any key on the user interface is pressed: it is then immediately switched off. If the unit is in CCN control mode, the pump status is displayed alternately with 'Forc' if its status is forced by CCN. During the test phase, pump supply is energised for 10 seconds only. When the test has finished, the following display appears: - Fail: displayed if the test has failed, because the pump is not started - Good: displayed if the test succeeds
11[1]	nn	- -	Evaporator heater and heat reclaim condenser status b1 = evaporator heater b2 = heat reclaim condenser heater
12[1]	tEst	%	Condenser water valve position in heat reclaim mode
13[1]		- - - -	Solenoid valve status/test, heat reclaim function b1 = heat reclaim coil shutoff solenoid valve, circuit A b2 = heat reclaim coil drain solenoid valve, circuit A b3 = heat reclaim coil shutoff solenoid valve, circuit B b4 = heat reclaim coil drain solenoid valve, circuit B In test mode the direction arrows permit successive display of 0001, 0010, 0100 and 1000, so as to in turn force authorisation of each output.
14	YES no tEst		Used only for local interface Cause all diodes and blocks to light up or flash, to verify that they are operating correctly

Legend

- 1 This item is displayed in certain unit configurations only
- 2 A test is only possible if the units are in local off mode and if all compressors have stopped
- 3 The password is only valid for the test. 'Test' is displayed during the test, alternating with the item number

4.5.6.3 - Manual tests

This function allows the user to test the outputs individually, if the machine is completely shut down (LOFF). To carry out a manual test use the arrow keys to access the output to be tested and press the Enter key (longer than 2 seconds) to activate the modification mode. The password is automatically requested, if it has not previously been verified. The Outputs/Test LED on the user interface begins to flash. Enter the desired test value and again press Enter to start the test. 'TEST' is displayed on the 4-digit display alternately with the value tested. The Outputs/Test LED stops flashing. Press the Enter key or an arrow key to stop the test.

4.5.7 - Description of the Configuration menu

4.5.7.1- General

This menu can be used to display and modify all configurations: Factory, Service and User. Only the User Configuration can be modified by the end-user. The Factory, Service and master/slave configurations are not described in this document. A configuration can only be modified if the unit is fully stopped (LOFF).

The menus User 1 [USER 1] and User 2 [USER 2] are password-protected. The other menus are directly accessible, except if item 6 of the User 1 menu (password for all configurations) has been validated.

4.5.7.2 - Password

A password must be entered in order to access the test function or to modify a configuration. It is automatically requested, if necessary: 'EntEr PASS' is displayed on the 4-digit display and the configuration menu LED flashes, indicating that the modification mode is active. Press the arrow keys until the value '11' is displayed on the 4-digit display. Press Enter to validate this. The configuration menu LED stops flashing. If the password is correct, 'Good' is displayed. If the password is incorrect, 'PASS incorrEct' is displayed. The User password has a default value of 11.

This value can be modified through the Service configuration. The password can be entered if the unit is fully stopped, otherwise 'ACCES dEniEd' (access denied) will be displayed on the 4-digit display. The controller automatically deactivates the password after 5 minutes without activity (i.e. no buttons pressed) or after powering up.

SUB-MENU USER CONFIGURATION

ITEM	USER 1 [USER1]	USER 2 [USER2]*	DATE [dAtE]*	SCHEDULE 1 [ScHEduLE 1 MEnu]*	SCHEDULE 2 [ScHEduLE 2 MEnu]*	HOLIDAYS [HOLIdAy MEnu]*	BROADCAST [BrodCAST]*
0	Return to previous menu	Return to previous menu*	Return to previous menu	Return to previous menu	Return to previous menu	Return to previous menu	Return to previous menu
1	Circuit selection	Periodic pump start-up*	Hour*	SUB-MENU: Period 1 [PErIod 1]	SUB-MENU: Period 1 [PErIod 1]	SUB-MENU: Holidays 1 [HOLIdAy 1]	Broadcast acknowledgement selection
2	Circuit capacity increase sequence	Night mode - start hour*	Day of the week*	SUB-MENU: Period 2 [PErIod 2]	SUB-MENU: Period 2 [PErIod 2]	SUB-MENU: Holidays 2 [HOLIdAy 2]	Broadcast activation
3	Ramp selection*	Night mode - end hour*	Day and month*	SUB-MENU: Period 3 [PErIod 3]	SUB-MENU: Period 3 [PErIod 3]	SUB-MENU: Holidays 3 [HOLIdAy 3]	Outdoor temperature broadcast bus
4	Start-up delay*	Night mode - demand limit in %	Year*	SUB-MENU: Period 4 [PErIod 4]	SUB-MENU: Period 4 [PErIod 4]	SUB-MENU: Holidays 4 [HOLIdAy 4]	Outdoor temperature broadcast element
5	Water pump selection	Number clock 1*	-	SUB-MENU: Period 5 [PErIod 5]	SUB-MENU: Period 5 [PErIod 5]	SUB-MENU: Holidays 5 [HOLIdAy 5]	Start month daylight saving time
6	Water pump changover delay*	Number clock 2*	-	SUB-MENU: Period 6 [PErIod 6]	SUB-MENU: Period 6 [PErIod 6]	SUB-MENU: Holidays 6 [HOLIdAy 6]	Start day daylight saving time
7	Automatic reset selection*	CCN address *	-	SUB-MENU: Period 7 [PErIod 7]	SUB-MENU: Period 7 [PErIod 7]	SUB-MENU: Holidays 7 [HOLIdAy 7]	Start hour daylight saving time
8	Demand limit selection	CCN bus*	-	SUB-MENU: Period 8 [PErIod 8]	SUB-MENU: Period 8 [PErIod 8]	SUB-MENU: Holidays 8 [HOLIdAy 8]	Minutes to add
9	Voltage corresponding to 100% of demand limit	-	-	-	-	SUB-MENU: Holidays 9 [HOLIdAy 9]	End month daylight saving time
10	Voltage corresponding to 0% of demand limit	-	-	-	-	SUB-MENU: Holidays 10 [HOLIdAy 10]	End day daylight saving time
11	Extended display selection	-	-	-	-	SUB-MENU: Holidays 11 [HOLIdAy 11]	End hour daylight saving time
12	Password for all user configurations	-	-	-	-	SUB-MENU: Holidays 12 [HOLIdAy 12]	Minutes to subtract
13	Software version number	-	-	-	-	SUB-MENU: Holidays 13 [HOLIdAy 13]	-
14	Total compressor current limit	-	-	-	-	SUB-MENU: Holidays 14 [HOLIdAy 14]	-
15	-	-	-	-	-	SUB-MENU: Holidays 15 [HOLIdAy 15]	-
16	-	-	-	-	-	SUB-MENU: Holidays 16 [HOLIdAy 16]	-

* Only displayed if configuration requires.

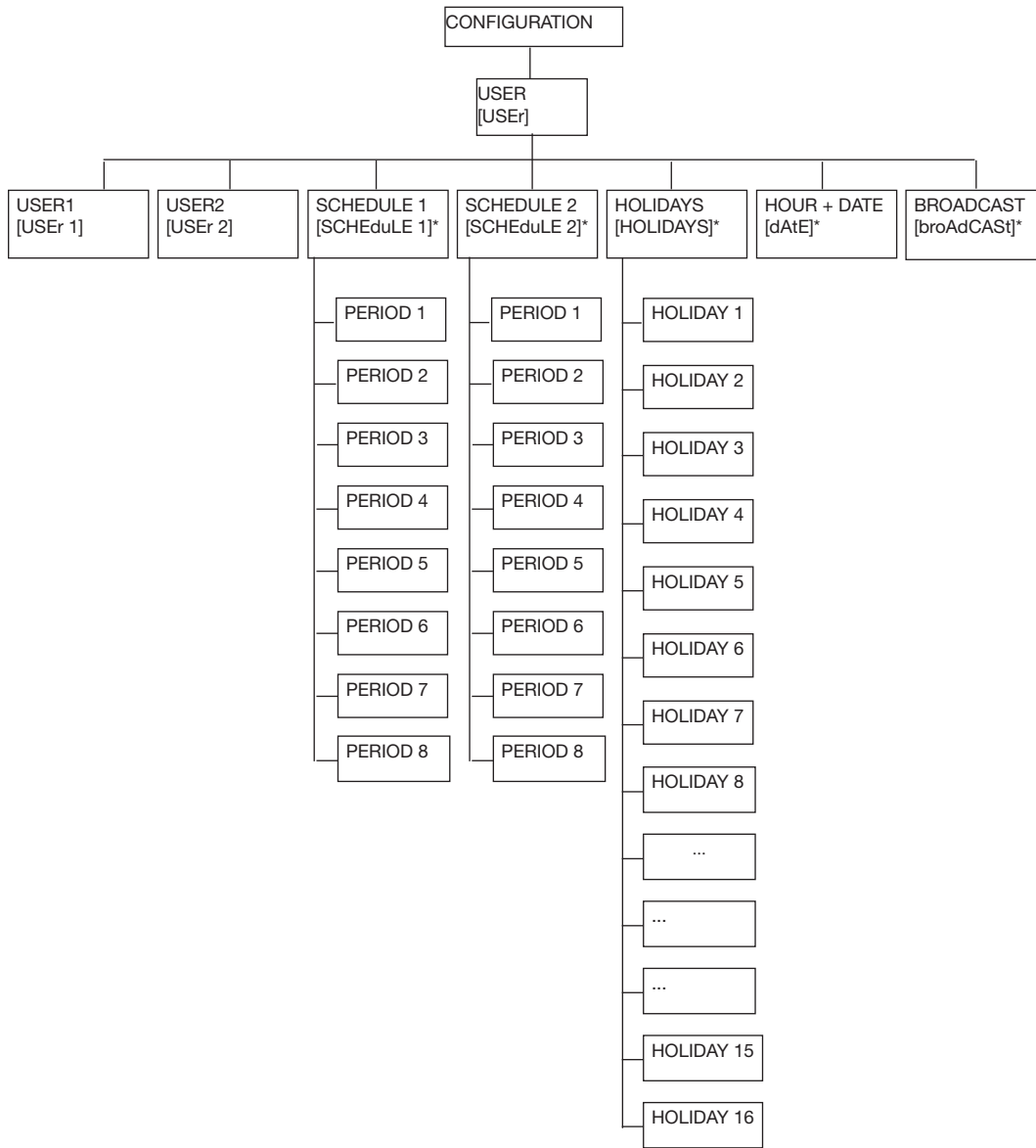

SUB-MENU PERIOD CONFIGURATION*

Item	PERIOD 1 to 8 [PERiod X MEnu]*
0	Return to previous menu
1	Start of occupied period
2	End of occupied period
3	Selection Monday
4	Selection Tuesday
5	Selection Wednesday
6	Selection Thursday
7	Selection Friday
8	Selection Saturday
9	Selection Sunday
10	Selection holidays

SUB-MENU HOLIDAY CONFIGURATION*

Item	HOLIDAYS 1 to 16 [HoLidAy X MEnu]*
0	Return to previous menu
1	Start month holidays
3	Start day holidays
4	Number of days, holidays

* Only displayed if configuration requires.

NOTE: The items in brackets show what is displayed on the user interface.

4.5.7.3 - Description of the User 1 Configuration sub-menu

USER 1 CONFIGURATION SUB-MENU [2]

ITEM	FORMAT	UNITS	DEFAULT	COMMENTS
0	USER MEnu	-	-	When selected this item authorises return to the previous menu.
1 [1]	0/1/2		0	Lead circuit selection 0 = automatic based on the number of start-ups and the operating hours of each circuit 1 = lead circuit A 2 = lead circuit B
2 [1]	0/1	-	0	Circuit capacity increase sequence 0 = equal charge for both circuits 1 = priority charge on one circuit
3 [1]	YES/no	-	no	Ramp loading select. For units with more than one compressor per circuit. Yes = ramp enabled No = ramp disabled This configuration enables the ramp to be activated for heating or cooling (depending on configuration): the maximum rate (in °C/min) of temperature drop or rise for the heat exchanger water (leaving or entering, upon configuration). Ramp setting value can be configured in the Setpoint menu.
4	1 to 15	min	1	Delay at start-up. This value is reinitialised after power-up or when both circuits are halted by local, remote or CCN command. No compressor will be started up until this pause has expired. However, the evaporator pump command will be activated immediately. The safety lockout loop will not be checked until the pause has expired.
5	0/1/2/3/4	-	0	Pump sequence select 0 = no pump 1 = one pump only 2 = two pumps with auto rotation 3 = pump #1 manual select 4 = pump #2 manual select If the auto sequence is selected, the pump change-over occurs when the rotation delay is elapsed. If the manual sequence is selected then, the selected pump is used in priority. Change-over occurs if one pump fails.
6 [1]	24 to 3000	hours	48	Pump changeover delay. Displayed if auto pump sequence is selected. This parameter is used for pump auto-rotation: the control tries to limit the pump run time difference to the pump changeover delay value. Change-over between pumps occurs when this difference becomes greater than the configured pump changeover delay.
7	0/1/2/3	-	0	Automatic reset selection. Permits activation of automatic reset type 0 = none 1 = 0-10 V d.c. reference voltage 2 = temperature difference 3 = outdoor temperature
8	0/1/2	-	0	Demand limit selection 0 = demand limit not selected 1 = demand limit by contact 2 = demand limit by external signal 0-10 V d.c.
9 [1]	0 to 10	Volts	0	Voltage corresponding to 100% of the demand limit
10 [1]	0 to 10	Volts	0	Voltage corresponding to 0% of the demand limit
11	«YES/no»	-	yes	Extended menu select Yes = menu description available No = menu description not available This item authorises activating or inhibiting the menu item expanded display.
12	«YES/no»	-	no	Password for all User Configurations Yes = password required for all User Configurations (Date, Time Schedule, Broadcast) No = password require for User menu only When this item is validated, the User Password will be required for all configurations accessible by the User.
13	nn.n	-	-	Software version number This item shows the number of the software version used by this controller. Access is read only.
14	nnnn	Amp	1500	Total compressor current limit This item is used to set the maximum limit for the total compressor running current (see paragraph "Pro-Dialog Plus control operations/Limiting the unit running current")

Legend

- 1 This item is masked when not used.
2 Access to menu is read/write.

4.5.7.4 - Description of the User 2 Configuration sub-menu

USER 1 CONFIGURATION SUB-MENU

ITEM	FORMAT	UNITS	DEFAULT	COMMENTS
0	USEr 2 Menu			When selected this item authorises return to the previous menu.
1[1]	YES/no	-	no	Periodic pump quick-start of the water pump(s) Yes = the pump is started periodically when the unit is manually stopped. No = periodic pump start is disabled When the unit is manually stopped (e.g. during the winter season) the pump is started each day at 14.00 hours for 2 seconds. If two pumps are available, pump #1 is started on odd days and pump #2 on even days.
2 [1]	n ₁ n ₂ n ₃ n ₄ 00:00 to 23:59	-	00:00	Night control mode - start time* Authorises entering the time of day at which the night control mode starts. During this period the fan runs at low speed (to reduce fan noise) if permitted by operating conditions, and unit capacity is limited to the maximum night values.
3 [1]	n ₁ n ₂ n ₃ n ₄ 00:00 to 23:59	-	00:00	Night control mode - end time* Authorises entering the time of day at which the night control mode ends.
4 [1]	0 to 100	%	-	Night mode demand limit value. Authorises configuration of the maximum capacity authorised during the night mode.
5 [1]	0 or 65 to 99	-	0	Schedule 1 clock number (for unit on/off schedule, see section 4.5.7.6). 0 = schedule in local operating mode 65 to 99 = schedule in CCN operating mode
6 [1]	0 or 65 to 99	-	0	Schedule 2 clock number (schedule for setpoint selection, see section 4.5.7.6). 0 = schedule in local operating mode 65 to 99 = schedule in CCN operating mode
7 [1]	1 to 239	-	1	CCN element address. No two network elements can have the same element number and bus number at the same time.
8 [1]	0 to 239	-	0	CCN bus number. No two network elements can have the same element number and bus number at the same time.

* n₁n₂: hours (00 to 23). The first time the Enter button is continuously pressed, the first two characters in the 4-digit display flash so that hours can be adjusted.
n₃n₄: minutes (00 to 59). Continuous pressing of the Enter key again causes the last two characters to flash so that minutes can be adjusted.

4.5.7.5 - Description of Date and Time configuration sub-menu

DATE & TIME CONFIGURATION SUB-MENU

ITEM	FORMAT	COMMENTS
0	dAtE MEnu	When selected this item authorises return to the previous menu.
1	n ₁ n ₂ n ₃ n ₄ 00:00 to 23:59	Current time setting. n ₁ n ₂ : hours (00 to 23). The first time the Enter button is continuously pressed, the first two characters in the 4-digit display flash so that hours can be adjusted. n ₃ n ₄ : minutes (00 to 59). Continuous pressing of the Enter key again causes the last two characters to flash and minutes can be adjusted.
2	«Mon» «tUe» «uEd» «tHu» «Fri» «SAT» «Sun»	Current day of week setting. Monday Tuesday Wednesday Thursday Friday Saturday Sunday
3	n ₁ n ₂ n ₃ n ₄ 01:01 to 31:12	Current day and month setting. n ₁ n ₂ :day (01 to 31). The first time the Enter button is continuously pressed, the first two characters in the 4-digit display flash so that day can be adjusted. n ₃ n ₄ :month (01 to 12). Continuous pressing of the Enter key again causes the last two characters to flash so that month can be adjusted.
4	nnnn	Current year setting.

4.5.7.6 - Description of the Time Schedules sub-menus

The control provides two timer programs. If the CCN/clock board is not installed, the two schedules are permanently in occupied mode.

The first timer program (schedule #1) provides a means to automatically switch the unit from an occupied mode to an unoccupied mode: the unit is started during occupied periods.

The second timer program (schedule #2) provides a means to automatically switch (when auto mode is selected) the active setpoint from an occupied setpoint to an unoccupied setpoint. Cooling or heating setpoint 1 is used during occupied periods. Cooling setpoint 2 is used during unoccupied periods. For additional information on setpoint activation see section 5.7.1.

Each schedule consists of eight time periods set by the operator. These time periods can be flagged to be in effect or not in effect on each day of the week plus a holiday period (see section 4.5.7.7 on public holidays). The day begins at 00.00 hours and ends at 24.00 hours.

Program is in unoccupied mode unless a schedule time period is in effect. If two periods overlap and are both active on the same day, the occupied mode takes priority over the unoccupied period.

Each of the eight periods can be displayed and changed with the aid of a sub-sub-menu. The table below shows how to access the period configuration. Method is the same for the time schedule #1 or the time schedule #2.

PERIOD X CONFIGURATION SUB-MENUS (X = 1 to 8)

ITEM #	FORMAT	COMMENTS
0	Period X Menu	Indicates the period (X) you are going to configure. When selected this item authorises a return to the main menu.
1	n ₁ n ₂ n ₃ n ₄ 00:00 to 24:00	Occupied period - Start time* . Authorises entering the time of day at which the occupied period starts.
2	n ₁ n ₂ n ₃ n ₄ 00:00 to 24:00	Occupied period - End time* . Authorises entering the time of day at which the occupied period ends.
3	Mo- 0 or Mo- 1	1 = the period is in effect on Monday . 0 = period not in effect on Monday
4	tu- 0 or tu- 1	1 = the period is in effect on Tuesday . 0 = period not in effect on Tuesday.
5	UE-0 or UE- 1	1 = the period is in effect on Wednesday . 0 = period not in effect on Wednesday.
6	tH- 0 or tH- 1	1 = the period is in effect on Thursday . 0 = period not in effect on Thursday.
7	Fr-0 or Fr- 1	1 = the period is in effect on Friday . 0 = period not in effect on Friday.
8	SA- 0 or SA- 1	1 = the period is in effect on Saturday . 0 = period not in effect on Saturday.
9	Su- 0 or Su- 1	1 = the period is in effect on Sunday . 0 = period not in effect on Sunday.
10	Ho- 0 or Ho- 1	1 = the period is in effect on public holidays . 0 = period not in effect on public holidays.

* n₁n₂: hours (00 to 24). The first time the Enter button is continuously pressed, the first two characters in the 4-digit display flash so that hours can be adjusted.
n₃n₄: minutes (00 to 59). Continuous pressing of the Enter key again causes the last two characters to flash so that minutes can be adjusted.

Typical timer program:

Time	MON	TUE	WES	THU	FRI	SAT	SUN	HOL
0	P1							
1	P1							
2	P1							
3								
4								
5								
6								
7	P2	P2	P3	P4	P4	P5		
8	P2	P2	P3	P4	P4	P5		
9	P2	P2	P3	P4	P4	P5		
10	P2	P2	P3	P4	P4	P5		
11	P2	P2	P3	P4	P4	P5		
12	P2	P2	P3	P4	P4			
13	P2	P2	P3	P4	P4			
14	P2	P2	P3	P4	P4			
15	P2	P2	P3	P4	P4			
16	P2	P2	P3	P4	P4			
17	P2	P2	P3					
18			P3					
19			P3					
20			P3					P6
21								
22								
23								
24								

MON : Monday
TUE : Tuesday
WED : Wednesday
THU : Thursday
FRI : Friday
SAT : Saturday
SUN : Sunday
HOL : Public holidays

 Occupied
 Unoccupied

	Starts at	Ends at	Active on
P1: period 1,	0h00,	3h00,	Monday
P2: period 2,	7h00,	18h00,	Monday and Tuesday
P3: period 3,	7h00,	21h00,	Wednesday
P4: period 4,	7h00,	17h00,	Thursday and Friday
P5: period 5,	7h00,	12h00,	Saturday
P6: period 6,	20h00,	21h00,	Public holidays
P7: period 7,	Not used in this example		
P8: period 8,	Not used in this example		

4.5.7.7 - Description of the Holidays sub-menus

This function is used to define 16 public holiday periods. Each period is defined with the aid of three parameters: the month, starting day and duration of the public holiday period. During these public holidays the controller will be in occupied or unoccupied mode, depending on the programmed periods validated for public holidays (see section 4.5.7.8).

Each of these public holiday periods can be displayed and changed with the aid of a sub-menu.

ATTENTION: The broadcast function must be activated to utilise the holiday schedule, even if the unit is running in stand-alone mode (not connected to CCN). See section 4.5.7.6.

HOLIDAY PERIOD X CONFIGURATION SUB-MENUS (X = 1 to 16)

ITEM #	FORMAT	COMMENTS
0	HoLidAy X Sub-menu	When selected this item authorises a return to the configuration menu.
1	0 to 12	Start month of public holiday period 0 = period not in use 1 = January, 2 = February, etc.
2	0 to 31	Start day of public holiday period. 0 period not in use.
3	0 to 99 days	Duration of the public holiday period in days.

Typical programming for public holidays:

A public holiday period lasting 1 day on 20th May, for instance, is configured as follows: start month = 5, start day = 20, duration = 1
A public holiday period lasting 2 day on 25th May, for instance, is configured as follows: start month = 5, start day = 25, duration = 2

4.5.7.8 - Description of the Broadcast sub-menu

The controller provides a broadcast configuration menu which you can use to configure the unit to be the CCN's broadcaster, responsible for transmitting the time, outdoor temperature, and holiday flags to all system elements.

This menu also authorises setting the date to begin and end daylight saving time. There should be **only one** broadcaster in a CCN, so this table should not be configured if any other system element is acting as broadcaster.

ATTENTION: If the unit operates in standalone mode (not CCN connected) this menu must be used if the holiday function is used, or to correct for daylight saving time.

BROADCAST CONFIGURATION SUB-MENU

ITEM #	FORMAT	COMMENTS
0	broAdCAST MEnu	When selected this item authorises a return to the main menu.
1	YES/no	Determines whether or not the unit is a broadcast acknowledged when the unit is connected on a CCN network. There must be only one broadcast acknowledged in a CCN. Warning: if the unit operates in standalone mode (not CCN connected) this choice must be set to Yes if the holiday function is used (see section 4.5.7.8) or if you want to configure the daylight saving time function.
2	YES/no	This item authorises enabling or disabling the Broadcast function . When it is set to Yes, the control will make a periodic broadcast on the CCN. When it is set to No, the control is not the broadcaster and there is no need to configure the other choice in this table. There must be only one broadcaster in a CCN and this item should not be configured if any other system element is acting as broadcaster. Warning: if the unit operates in standalone (not CCN connected) this choice must be set to Yes if the holiday function is used (see section 4.5.7.8) or if you want to configure the daylight saving time function.
3	nnn 0 to 239	OAT Broadcaster bus number: it is the bus number of the system that has the outside air temperature sensor connected to it. Used for CCN network function only.
4	nnn 0 to 239	OAT Broadcaster element number: it is the element number of the system element that has the outside air temperature sensor connected to it. Used for CCN network function only.
5	nn 1 to 12	Daylight saving start month. In this mode you enter the month in which the broadcaster will adjust its time for the start of daylight saving time.
6	nn 1 to 31	Daylight saving start day. In this mode you enter the day on which the broadcaster will adjust its time for the start of daylight saving time.
7	n ₁ n ₂ n ₃ n ₄ 00:00 to 24:00	Authorises entering the hours and minutes for saving start. In this mode you enter the time of day when the broadcaster will adjust its time for the start of daylight saving time. n ₁ n ₂ : hours (00 to 24). The first time the Enter button is continuously pressed, the first two characters in the 4-digit display flash so that hours can be adjusted. n ₃ n ₄ : minutes (00 to 59). Continuous pressing of the Enter key again causes the last two characters to flash so that minutes can be adjusted.
8	nnnn 1 to 1440 minutes	Daylight saving start minutes to add: number of minutes by which the broadcaster will adjust its time for the start of daylight saving time.
9	nn 1 to 12	Daylight saving stop month. In this mode you enter the month in which the broadcaster will adjust its time for the end of daylight saving time.
10	nn 1 to 31	Daylight saving stop day. In this mode you enter the day on which the broadcaster will adjust its time for the end of daylight saving time.
11	n ₁ n ₂ n ₃ n ₄ 00:00 to 24:00	Authorises entering the hours and minutes for saving stop. In this mode you enter the time of day when the broadcaster will adjust its time for the end of daylight saving time.
12	nnnn 1 to 1440 minutes	Daylight saving start minutes to subtract: number of minutes by which the broadcaster will adjust its time for the end of daylight saving time.

Legend

n₁n₂: hours (00 to 24). The first time the Enter button is continuously pressed, the first two characters in the 4-digit display flash so that hours can be adjusted.
n₃n₄: minutes (00 to 59). Continuous pressing of the Enter key again causes the last two characters to flash so that minutes can be adjusted.

4.5.8 - Description of the Alarms menu

This menu is used to display and reset up to 5 active alarms. It also permits alarm reset. If no alarm is active this menu is not accessible. See section 6 for a complete description of the alarm codes and alarm reset.

ALARMS MENU

ITEM #	FORMAT	DESCRIPTION
0 [1]	X ALArM rESEt ALArM	X alarms are active Reset of alarms is requested To reset all active alarms, continuously press the Enter key. 'rESEt ALArM' is then displayed. Press the select key again: all alarms are reset.
1 [1]	nn	Current alarm code 1*
2 [1]	nn	Current alarm code 2*
3 [1]	nn	Current alarm code 3*
4 [1]	nn	Current alarm code 4*
5 [1]	nn	Current alarm code 5*

Legend

1 This item is masked when nil
* Pressing the Enter key when alarm code is displayed causes the following message to be scrolled:
"time of alarm" "date of alarm" "full CCN alarm message"
- "time of alarm": hh-mm
- "date": dd-mm
- "full CCN alarm message": up to 64 characters

4.5.9 - Description of the Alarms History menu

ALARMS HISTORY MENU

ITEM #	FORMAT	COMMENTS
1 [1]	nn	Alarm history code 1*
2 [1]	nn	Alarm history code 2*
3 [1]	nn	Alarm history code 3*
4 [1]	nn	Alarm history code 4*
5 [1]	nn	Alarm history code 5*
6 [1]	nn	Alarm history code 6*
7 [1]	nn	Alarm history code 7*
8 [1]	nn	Alarm history code 8*
9 [1]	nn	Alarm history code 9*
10 [1]	nn	Alarm history code 10*

Legend

1 This item is masked when nil
* Pressing the Enter key when alarm code is displayed causes the following message to be scrolled:
"time of alarm" "date of alarm" "full CCN alarm message"
- "time of alarm": hh-mm
- "date": dd-mm
- "full CCN alarm message": up to 64 characters

4.5.10 - Runtime menu description

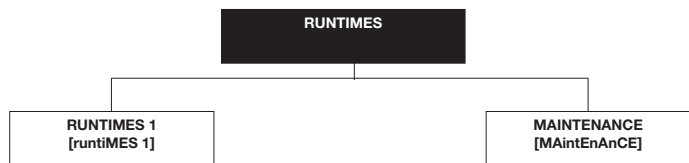

NOTE: The items in brackets show what is displayed on the user interface.

4.5.10.1 - Description of the Runtimes 1 menu

RUNTIMES MENU [2]

ITEM #	FORMAT	UNIT	COMMENTS
0	-	-	When selected this item authorises return to the previous menu
1	nnnn M 10 M100	hrs/10 or 100	Unit operating hours*
2 [1]	nnnn M 10 M100	hrs/10 or 100	Compressor A1 operating hours*
3 [1]	nnnn M 10 M100	hrs/10 or 100	Compressor A2 operating hours*
4 [1]	nnnn M 10 M100	hrs/10 or 100	Compressor B1 operating hours*
5 [1]	nnnn M 10 M100	hrs/10 or 100	Compressor B2 operating hours*
6	nnnn M 10 M100	-/10 or 100	Machine starts*
7	nnnn M 10 M100	-/10 or 100	Compressor A1 starts*
8 [1]	nnnn M 10 M100	-/10 or 100	Compressor A2 starts*
9 [1]	nnnn M 10 M100	-/10 or 100	Compressor B1 starts*
10 [1]	nnnn M 10 M100	-/10 or 100	Compressor B2 starts*
11	nnnn	-	Number of start-ups for the compressor with the highest number during the last hour
12 [1]	nnnn	-	Average number of compressor start-ups/hour for the last 24 hours
13 [1]	nnnn M 10 M100	hrs/10 or 100	Pump #1 operating hours*
14 [1]	nnnn M 10 M100	hrs/10 or 100	Pump #2 operating hours*
15 [1]	nnnn M 10 M100	hrs/10 or 100	Condenser pump operating hours

Legend

1 This item is masked when not used

* Certain values are divided by 10 or by 100, so that number of hours or start-ups of less than 10 are displayed as 0.

When the value is divided by 10 or by 100 it is displayed in turn with "M 10" or "M100".

4.5.10.2 - Maintenance menu description

To be active, the maintenance function must be preset in the Service configuration.

ITEM #	FORMAT	DESCRIPTION
0	MAintEnAnCE MMenu	When selected this item authorises return to the previous menu.
1 [1]		Accessible with the Service password.
2 [1]		For future use
3 [1]		For future use
4 [1]	ALert	Water loop rate to low
5 [1]	nnn/ALert	Next primary pump maintenance operation in nnn days. 'ALert' is displayed, when the delay before maintenance has elapsed.
6 [1]	nnn/ALert	Next secondary pump maintenance operation in nnn days. 'ALert' is displayed, when the delay before maintenance has elapsed.
7 [1]	nnn/ALert	Next water filter maintenance operation in nnn days. 'ALert' is displayed, when the delay before maintenance has elapsed.

Legend

1 This item is masked when not used.

5 - PRO-DIALOG PLUS CONTROL OPERATION

5.1 - Start/stop control

The table below summarises the unit control type and stop or go status with regard to the following parameters.

- **Operating type:** this is selected using the start/stop button on the front of the user interface.
- **Remote start/stop contacts:** these contacts are used when the unit is in remote operating type (rEM). See sections 3.6.2 and 3.6.3.
- **CHIL_S_S:** this network command relates to the chiller start/stop when the unit is in CCN control (CCn). Variable forced to disable: the unit is halted. Variable forced to Enable: the unit runs in accordance with schedule 1.

- **Start/Stop schedule:** occupied or unoccupied status of the unit as determined by the chiller start/stop program (Schedule #1). Used when the unit is equipped with an optional CCN/clock board, otherwise the chiller occupied mode is forced to occupied all the time.
- **Master control type.** This parameter is used when the unit is the master unit in a two chiller lead/lag arrangement. The master control type determines whether the unit is to be controlled locally, remotely or through CCN (this parameter is a Service configuration).
- **CCN emergency shutdown:** if this CCN command is activated, it shuts the unit down whatever the active operating type.
- **General alarm:** the unit is totally stopped due to failure.

ACTIVE OPERATING TYPE							PARAMETER STATUS					CONTROL TYPE	UNIT MODE
LOFF	L-ON	L-SC	rEM	CCN	MASt	CHIL_S_S	REMOTE START/STOP CONTACT	MASTER CONTROL TYPE	START/STOP SCHEDULE MODE	CCN EMERGENCY SHUTDOWN	GENERAL ALARM		
-	-	-	-	-	-	-	-	-	-	Enable	-	-	Off
-	-	-	-	-	-	-	-	-	-	-	Yes	-	Off
Active	-	-	-	-	-	-	-	-	-	-	-	Local	Off
-	-	Active	-	-	-	-	-	-	Unoccupied	-	-	Local	Off
-	-	-	Active	-	-	-	Off	-	-	-	-	Remote	Off
-	-	-	Active	-	-	-	-	-	Unoccupied	-	-	Remote	Off
-	-	-	-	Active	-	Disable	-	-	-	-	-	CCN	Off
-	-	-	-	Active	-	-	-	-	Unoccupied	-	-	CCN	Off
-	-	-	-	-	Active	-	-	Local	Unoccupied	-	-	Local	Off
-	-	-	-	-	Active	-	Off	Remote	-	-	-	Remote	Off
-	-	-	-	-	Active	-	-	Remote	Unoccupied	-	-	Remote	Off
-	-	-	-	-	Active	Disable	-	CCN	-	-	-	CCN	Off
-	-	-	-	-	Active	-	-	CCN	Unoccupied	-	-	CCN	Off
-	Active	-	-	-	-	-	-	-	-	Disable	No	Local	On
-	-	Active	-	-	-	-	-	-	Occupied	Disable	No	Local	On
-	-	-	Active	-	-	-	On	-	Occupied	Disable	No	Remote	On
-	-	-	-	Active	-	Enable	-	-	Occupied	Disable	No	CCN	On
-	-	-	-	-	Active	-	-	Local	Occupied	Disable	No	Local	On
-	-	-	-	-	Active	-	On	Remote	Occupied	Disable	No	Remote	On
-	-	-	-	-	Active	Enable	-	CCN	Occupied	Disable	No	CCN	On

5.2 - Heating/cooling selection

On heat pumps, heating/cooling selection can be controlled differently depending on the active operating type:

- Locally on the unit, using operating types L-C1, L-C2, LC1r and LC2r (for cooling) and L-H (for heating).
- Remotely using the heat/cool selection volt-free contact when the unit is in Remote operating type (rEM).
- Via a CCN command when the unit is in CCN operating type (CCn).

The current heat/cool operating mode on the unit is indicated by item 4 in the Information menu and by the heat/cool LEDs on the summary interface.

PARAMETER STATUS					
ON/OFF STATUS	CONTROL TYPE	HEATING/COOLING SELECTION IN LOCAL MODE	REMOTE HEATING/COOLING CONTACTS	HC_SEL	OPERATING MODE
Off	-	-	-	-	Cooling
On	Local	Cooling	-	-	Cooling
On	Local	Heating	-	-	Heating
On	Remote	-	Cooling mode	-	Cooling
On	Remote	-	Heating mode	-	Heating
On	CCN	-	-	Cooling	Cooling
On	CCN	-	-	Heating	Heating

5.3 - Evaporator water pump control

The unit can control one or two evaporator water pumps. The evaporator water pump is turned on when this option is configured (see User configuration) and when the unit is in one of the on modes described above or in delay mode. Since the minimum value for the delay at start-up is 1 minute (configurable between 1 and 15 minutes), the pump will run for at least one minute before the first compressor starts.

The pump is kept running for 20 seconds after the unit goes to stop mode. The pump keeps working when the unit switches from heating to cooling mode or vice-versa. It is turned off if the unit is shut down due to an alarm unless the fault is a frost protection error.

The pump can be started in particular operating conditions when the evaporator heater is active. See section 5.21 for the particular evaporator pump control for the follower unit (master/slave assembly). If two pumps are controlled and the reversing function has been selected (see User 1 configuration), the control tries to limit the pump run time delta to the configured pump change-over delay. If this delay has elapsed, the pump reversing function is activated, when the unit is running. During the reversing function both pumps run together for two seconds. If a pump has failed and a secondary pump is available, the unit is stopped and started again with this pump.

The control provides a means to automatically start the pump each day at 14.00 hours for 2 seconds when the unit is off. If the unit is fitted with two pumps, the first pump is started on odd days and the second pump is started on even days. Starting the pump periodically for few seconds increases the life-time of the pump bearings and the tightness of the pump seal.

NOTE: If this function is used, there should not be any chilled water pump interlock between terminals 34 and 35 (see section 3.4).

5.4 - Condenser water pump control

Only available on water-cooled units.

The condenser pump can be controlled by two modes, depending on the configuration (only accessible by Carrier Service).

1. Control based on unit start/stop control. In this case it is controlled in the same way as the evaporator pump.
2. Control based on compressor status. In this case the pump is activated at the same time as the first compressor. It only switches off when no compressor is activated.

5.5 - Control interlock contact

This contact can prevent unit start-up if it is open and if the start-up delay has passed. Furthermore, this contact must remain closed when the unit is not in local off, remote or CCN control mode. Opening this contact for more than 8 seconds while the unit is operating, will cause immediate shut-down of the faulty unit.

5.6 - Evaporator heater control

The evaporator heater can be activated to protect an evaporator that may be damaged by ice, if the unit is shut down for a long period at low outdoor air temperature. If the heater is not sufficient to increase the water temperature, the evaporator pump can be started.

NOTE: The evaporator heater control parameters may be modified using the Service Configuration menu.

5.7 - Control point

Control point represents the leaving water temperature that the unit must produce.

- In cooling mode: control point = active setpoint + reset
- In heating mode: control point = active setpoint - reset

5.7.1 - Active setpoint

Two setpoints can be selected as active in cooling mode. Usually, the second setpoint is used for unoccupied periods or for ice storage (medium or low brine unit). A single setpoint is available in heating mode.

Depending on the current operating mode, the active setpoint can be selected with the operating type selector button, or with the user's volt-free contacts, or with network commands (see section 3.4).

5.7.2 - Reset

Reset means that the active setpoint is modified so that less machine capacity is required (in cooling mode, the setpoint is increased, in heating mode it is decreased). This modification is in general a reaction to a drop in the load. For the Pro-Dialog Plus control system, the source of the reset can be configured in the User 1 configuration: it can be based on an external 0-10 V signal, provided either by the outdoor temperature (that gives a measure of the load trends for the building) or by the return water temperature (delta T that gives an average building load). In response to a drop in the outdoor temperature or to a drop in delta T, the cooling setpoint is normally reset upwards in order to optimise unit performance:

In both cases the reset parameters, i.e. slope, source and maximum value, are configurable in the Setpoints menu (see section 4.5.4). Reset is a linear function based on three parameters.

- A reference at which reset is zero (outdoor temperature or delta T - no reset value).
- A reference at which reset is maximum (outdoor temperature or delta T - full reset value).
- The maximum reset value.

5.8 - Demand limit

Generally, demand limit is used by an energy management system in order to restrict the unit electricity consumption.

The PRO-DIALOG Plus control system for 30GX and 30HX provides two methods of demand limit:

- By reference to a limiting signal from a user-controlled volt-free contact: the capacity of the unit cannot exceed the demand limit setpoint (which can be modified in the Setpoints menu) when the limit contact is closed.
- By reference to an external 0-10 V d.c. signal: the capacity of the unit cannot exceed the demand limit imposed by this external signal. It is a linear function and its parameters are configurable in the User1 menu (voltages at 0% limitation and 100% of limitation). This function is not available if reset by reference to an external 0-10 V d.c. signal has already been selected.

Whatever the method used, demand limit is active in all operating types: Local, Remote or CCN. However, in Local operating type, demand limit can be disabled with keypad commands (see section 4.3.3) and in CCN operating type, demand limit can be controlled directly with the aid of CCN commands.

NOTE: A limitation value of 100% means that the unit may call upon the full array of its capacity stages.

Here is an example of demand limit by an external 0-10 V d.c. signal. This example assumes that the limitation parameters are such that at 0 volt the authorised capacity shall be maximum capacity, and at 10 volts the authorised capacity shall be zero (this is the default configuration).

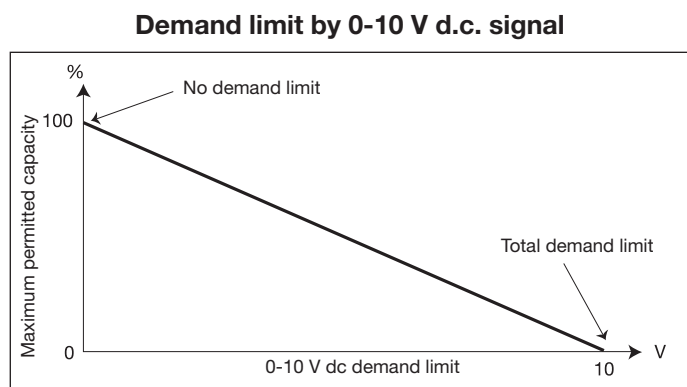

5.9 - Limiting the unit running current

This feature is used to avoid tripping the circuit breaker by:

- prohibiting an increase in compressor capacity when the current reaches a first threshold.
- unloading one or more capacity stages when a second protection threshold is reached.

See chapter: Description of the user 1 configuration sub-menu.

5.10 - Capacity control

This function adjusts the number of active compressors and loaders to keep the leaving water temperature at its setpoint. The precision with which this is achieved depends on the capacity of the water loop, the flow rate, the load, and the number of stages available on the unit.

The control system continuously takes account of the temperature error with respect to the setpoint, as well as the rate of change in this error and the difference between entering and leaving water temperatures, in order to determine the optimum moment at which to add or withdraw a capacity stage.

NOTE: If the same compressor undergoes too many starts (per hour) this automatically brings about reduction of compressor starts, which makes leaving water temperature control less precise.

5.11 - Determining the lead circuit

This function commands the start/stop sequence of the two refrigerant circuits called A and B. The circuit authorised to start first is the lead circuit. Three methods can be configured by the user in the Configuration menu:

- **Auto mode:** the control system determines the lead circuit so as to equalise the number of starts on each circuit (value weighted by the operating times of each circuit). Thus, the circuit with the least number of starts is always given precedence to start. The lead circuit is stopped last.
- **Circuit A as leader:** Circuit A is always the lead circuit. It is the first to start and the last to stop.
- **Circuit B as leader:** Circuit B is always the lead circuit. It is the first to start and the last to stop.

5.12 - Circuit loading sequence

Two circuit loading sequences are available. The choice of sequence can be configured by the user in the Configuration menu (see section 4.5.7.3).

- **Balanced circuit loading:** If this sequence is selected, the control system tries to keep the capacity of circuits A and B equal as the total load on the unit increases or decreases.
- **Loading with priority given to one circuit:** If this sequence is selected, the control system loads the lead circuit completely before the second circuit starts up. When there is a demand limit, the second circuit is unloaded first.

NOTE: 30HX and 30GX units use 06N twin-screw compressors. The screw compressor efficiency is better at full load than at part load. By default the 'close control'* configuration is not validated, and the control will always try to optimise unit efficiency.

* temperature precision has priority over compressor capacity. This parameter is only accessible to Carrier Service.

5.13 - Compressor start-up sequence in one circuit

The first compressor to start is the one with the least number of start-ups and operating hours. If both compressors are operating and the load decreases, the compressor that started first shuts down. This avoids cycling of the same compressor.

5.14 - EXV control

The electronic expansion valves (EXVs) control charging and the refrigerant flow in the evaporator, maintaining the optimum evaporator throttle and a correct discharge superheat. Opening the valve permits reduction of the throttle, and thus improves the heat exchange in the evaporator. This opening can be limited to maintain the condenser subcooling and correct superheat, avoiding liquid slugging at the compressors and ensuring operating stability.

5.15 - Motor cooling valve control

The temperature of the motor windings is controlled to a setpoint of 82°C. This is achieved by cycling of the motor cooling valves to allow the liquid refrigerant to flow across the motor windings, if necessary. On units equipped with economizers with plate heat exchangers, a thermostatic valve controls the necessary refrigerant flow entering this heat exchanger and continuously flowing over the motor windings. All refrigerant used for motor cooling returns to the rotors through an orifice situated mid-way along the compression cycle and is compressed to the discharge pressure.

5.16 - Head pressure control on air-cooled units

The saturated condensing temperature is controlled by reference to a fixed setpoint (user-definable in the Setpoints menu). This temperature is maintained by cycling fans on and off, as well as by varying the speed of a fan.

NOTE: *Certain units can have up to 8 fan stages, of which one per circuit is a variable speed fan, depending on their configuration and wiring.*

5.17 - Head pressure control on water-cooled units

The saturated condensing temperature is controlled by reference to a user-definable fixed setpoint.

This temperature is maintained by using the valve to control the flow of water in each condenser circuit.

5.18 - Head pressure setpoint selection

There are two head pressure setpoints available: the first is called “head pressure setpoint” and the second “reclaim setpoint”. These setpoints only have an effect when the control system is controlling head pressure: air or water-cooled units operating in cooling mode (only when they are fitted with condenser water valves).

The active setpoint can be selected in one of the following ways:

- With item 5 of the information menu.
- With a volt-free selection contact connected to the customer terminal block when the unit is in Remote operating type (rEM). See section 3.4, description of the control contacts.
- With a network command when the unit is in CCN operating type (CCn).

5.19 - High pressure load shedding function

This function does not require an additional board. It prevents high pressure breaks on a circuit by the following means:

- Preventing any capacity increase on the circuit once the high pressure value has reached an initial threshold.
- Shedding one or more capacity stages once a second protection threshold has been reached.

In the event of capacity stages being shed, no capacity increase will be authorised on the circuit concerned for a period of 5 minutes.

NOTE: *The last capacity stage cannot be shed by this protection function. An alarm is activated, if the high pressure is still too high.*

5.20 - High current load shedding function

This function does not require an additional board. It prevents high current breaks on each compressor by the following means:

- Preventing any capacity increase on the compressor once the high current value has reached an initial threshold
- Shedding one or more capacity stages once a second protection threshold has been reached.

In the event of capacity stages being shed, no capacity increase will be authorised on the circuit concerned for a period of 5 minutes.

5.21 - Start-up procedure - pre-lubrication

This procedure describes the necessary operations to ensure the lubrication of the compressor before start-up.

The control follows the sequence below:

For the lead compressor (the first compressor in the circuit to start):

1. Measure the initial oil pressure.
2. Activate the oil solenoid valve and start up the oil pump.
3. Wait approximately 15 seconds.
4. If oil pressure increases, pre-lubrication is assured and the compressor can start.
5. If not, a further pre-lubrication cycle is started. Return to point 1.

NOTE: *After three cycles, the low oil pressure alarm at pre-start-up is activated, and prelubrication is also stopped.*

For the lag compressor (one compressor in the circuit is already in operation).

1. Activate the oil solenoid valve.
2. Wait approximately 15 seconds.
3. If oil pressure increases, pre-lubrication is assured and the compressor can now start.
4. If not, the low oil pressure at start-up alarm is activated and the pre-lubrication is also stopped.

5.22 - Master/slave assembly

Two PRO-DIALOG Plus units can be linked to produce a master/slave assembly. The two machines are interconnected over the CCN bus. All parameters required for the master/slave function must be configured through the Service configuration menu.

Master/slave operation requires the connection of a temperature probe at the common manifold on each machine, if the heat exchanger leaving water temperature is controlled.

The master/slave assembly can operate with constant or variable flow. In the case of variable flow each machine must control its own water pump and automatically shut down the pump, if the cooling capacity is zero. For constant flow operation the pumps for each unit are continuously operating, if the system is operating. The master unit can control a common pump that will be activated, when the system is started. In this case the slave unit pump is not used.

All control commands to the master/slave assembly (start/stop, setpoint, heating/cooling operation, load shedding, etc.) are handled by the unit which is configured as the master, and must therefore only be applied to the master unit. They will be transmitted automatically to the slave unit. The master unit can be controlled locally, remotely or by CCN commands. Therefore to start up the assembly, simply validate the Master operating type (MASt) on the master unit. If the Master has been configured for remote control then use the remote volt-free contacts for unit start/stop. The slave unit must stay in CCN operating type continuously. To stop the master/slave assembly, select Local Off (LOFF) on the master unit or use the remote volt-free contacts if the unit has been configured for remote control.

One of the functions of the master unit (depending on its configuration) may be the designation, whether the master or slave is to be the lead machine or the follower. The roles of lead machine and follower will be reversed when the difference in running hours between the two units exceeds a configurable value, ensuring that the running times of the two units are automatically equalised. The changeover between lead machine and follower may take place when the assembly is started up, or even whilst running. The running time balancing function is not active if it has not been configured: in this case the lead machine is always the master unit.

The lead machine will always be started first. When the lead machine is at its full available capacity, start-up delay (configurable) is initialised on the follower. When this delay has expired, and if the error on the control point is greater than 1.7°C, the follower unit is authorised to start and the pump is activated. The follower will automatically use the master unit active setpoint. The lead machine will be held at its full available capacity for as long as the active capacity on the follower is not zero. When the follower unit receives a command to stop, its evaporator water pump is turned off with 20 seconds delay.

In the event of a communication fault between the two units, each shall return to an autonomous operating mode until the fault is cleared. If the master unit is halted due to an alarm, the slave unit is authorised to start without prior conditions.

5.23 - Controlling Pro-Dialog Plus units with a System Manager

Up to eight PRO-DIALOG Plus units (or System Manager compatible units) can be controlled by one control module of the FSM or CSM III type which can handle multi-tasking of control functions such as starting units in sequence.

5.24 - Optional heat reclaim module

This option only applies to air-cooled units, equipped with a water-cooled heat reclaim condenser. An additional 4 x DO board must be installed. This board permits control of:

- two solenoid shutoff valves for the heat reclaim coil, one per circuit.
- two drain solenoid valves, one per circuit. These permit draining the refrigerant from the inactive coil, when the unit changes over from the cooling mode to the heat reclaim mode.

Selecting the heat reclaim mode can be done with either the local interface or remotely with the (recl_sw) contact or by CCN.

The heat reclaim function is active when: the heat reclaim entering water temperature is lower than the heat reclaim setpoint, minus half of the heat reclaim dead band.

The heat reclaim function is not active when: the heat reclaim entering water temperature is higher than the heat reclaim setpoint, plus half of the heat reclaim dead band.

In the dead band the function remains in its active mode. The default value of the dead band is 4.4°C. This value can be modified by Carrier Service.

Change-over procedure from cooling mode to heat reclaim mode:

- Start-up of the condenser pump
- Verification of the condenser flow switch control contact. If this remains open after one minute of condenser pump operation, the circuit remains in cooling mode and alarm 83 for circuit A (alarm 84 for circuit B) will be activated.
- As soon as the saturated condensing temperature reaches 30°C and the superheat reaches 8.3 K, the pumpdown sequence is activated.
- Pumpdown: closing of the cooling mode coil shutoff valve. Opening of the drain valve, closing of the EXV valve.
- When the pumpdown pressure reaches the end of the pump-down threshold, the pumpdown valve is closed and the heat reclaim function is effective.

Item 17 and 18 of the INFORMATION menu permits consulting different heat reclaim function sequences:

- 17 = sequence of circuit A
- 18 = sequence of circuit B
- 0 = cooling mode
- 1 = heat reclaim mode selection
- 2 = pumpdown sequence
- 3 = effective heat reclaim mode
- 4 = pumpdown fault*
- 5 = water flow switch fault*

* Alarm 83 for circuit A or 84 for circuit B is activated. Consulting the items 17 and 18 gives cause as (4) or (5). Resetting of the alarms re-initialises the information.

6 - DIAGNOSTICS - TROUBLESHOOTING

6.1 - General

The PRO-DIALOG Plus control system has many fault tracing aid functions. The local interface and its various menus give access to all unit operating conditions. The test function makes it possible to run a quick test of all devices on the unit. If an operating fault is detected, an alarm is activated and an alarm code is stored in the Alarm menu.

6.2 - Displaying alarms

The alarm LEDs on the summary interface (see section 4.1) give a quick display of the status of each circuit and the unit as a whole.

- A flashing LED shows that the circuit is operating but there is an alarm.
- A steady LED shows that the circuit has been shut down due to a fault.

The Alarm menu on the main interface displays up to 5 fault codes that are active on the unit.









6.3 - Resetting alarms

When the cause of the alarm has been corrected the alarm can be reset, depending on the type, either automatically on return to normal, or manually when action has been taken on the unit. Alarms can be reset even if the unit is running.

This means that an alarm can be reset without stopping the machine. In the event of a power supply interrupt, the unit restarts automatically without the need for an external command. However, any faults active when the supply is interrupted are saved and may in certain cases prevent a circuit or a unit from restarting.

A manual reset must be run from the main interface using the following procedure:

RESET OF ACTIVE ALARMS

OPERATION	ITEM NUMBER	ITEM VALUE	PRESS	MENU
	2-DIGIT DISPLAY	4-DIGIT DISPLAY	BUTTON	LED
Hold down the MENU button until the LED for alarms lights. The 4-digit display shows the number of active alarms (2 in this example).	0			
	0	2 ALArM		
Press the Enter button until "rESEt ALARrM" is shown in the 4-digit display.	0	rESEt ALArM		
Press the Enter button again to validate the reset. "Good" is displayed for 2 seconds then, "2 ALArM" and then, "no ALArM".	0	Good then, 2 AL then, no ALArM		

6.4 - Alarm codes

The following list gives a complete description of each alarm code and its possible cause.

Alarm code	Description	Why was this alarm generated?	Action taken by the control	Reset type	Probable cause
1	Evaporator entering fluid thermistor failure	Thermistor outside range -40 to 118°C	Unit shut down	Auto, if the temperature measured by the sensor becomes normal again	Thermistor or wiring fault or cable/wire damaged
2	Evaporator leaving fluid thermistor failure	Ditto	Unit shut down	Ditto	Ditto
3	Condenser entering fluid thermistor failure	Ditto	None, simple message	Ditto	Ditto
4	Condenser leaving fluid thermistor failure	Ditto	None in cooling mode Unit shut down in heating mode	Ditto	Ditto
5	Condenser entering fluid thermistor failure	Ditto	None, simple message	Ditto	Ditto
6	Condenser leaving fluid thermistor failure	Ditto	None	Ditto	Ditto
7	Outdoor temperature sensor fault	Ditto	Reset based on deactivated outdoor sensor	Ditto	Ditto
8	CHWS (master/slave) fluid thermistor fault	Ditto	Master/slave function deactivated	Ditto	Ditto
9	Compressor A1, discharge gas sensor	Ditto	Compressor A1 shut down	Ditto	Thermistor, solenoid, motor cooling or wiring fault
10	Compressor A2, discharge gas sensor	Ditto	Compressor A2 shut down	Ditto	Ditto
11	Compressor B1, discharge gas sensor	Ditto	Compressor B1 shut down	Ditto	Ditto
12	Compressor B2, discharge gas sensor	Ditto	Compressor B2 shut down	Ditto	Ditto
13	External 0-10 V dc signal fault	Signal outside range	1- Loadshed: not used 2- Demand limit: deactivated	Ditto	Defective input or wiring fault
14	Discharge pressure transducer failure, circuit A	Measured signal = 0 V dc	Circuit A shut down	Ditto	Defective transducer, wiring fault
15	Discharge pressure transducer failure, circuit B	Ditto	Circuit B shut down	Ditto	Ditto
16	Suction pressure transducer failure, crt A	Ditto	Circuit A shut down	Ditto	Ditto
17	Suction pressure transducer failure, crt B	Ditto	Circuit B shut down	Ditto	Ditto
18	Oil pressure transducer failure, compr A1	Ditto	Compressor A1 shut down	Ditto	Ditto
19	Oil pressure transducer failure, compr A2	Ditto	Compressor A2 shut down	Ditto	Ditto
20	Oil pressure transducer failure, compr B1	Ditto	Compressor B1 shut down	Ditto	Ditto
21	Oil pressure transducer failure, compr B2	Ditto	Compressor B2 shut down	Ditto	Ditto
22	Economizer A1 transducer failure	Ditto	Circuit A shut down for unit with economizer. Otherwise compressor A1 shut down.	Ditto	Ditto
23	Economizer A2 transducer failure	Ditto	Compressor A2 shut down	Ditto	Ditto
24	Economizer B1 transducer failure	Ditto	Circuit B shut down for unit with economizer. Otherwise compressor B1 shut down.	Ditto	Ditto
25	Economizer B2 transducer failure	Ditto	Compressor B2 shut down	Ditto	Ditto
26	Pressure sensor failure - coil pump down circuit A	Ditto	Circuit A remains in cooling mode	Ditto	Ditto
27	Pressure sensor failure - coil pump down circuit B	Ditto	Circuit B remains in cooling mode	Ditto	Ditto
28	Fault in the motor cooling valve position sensor, circuit A	Ditto	None	Ditto	Ditto
29	Fault in the motor cooling valve position sensor, circuit B	Ditto	None	Ditto	Ditto
30	Loss of communication with SCPM A1 board	SCPM A1 board does not respond	Compressor A1 shut down	Ditto	Wiring fault, incorrect address or defective board
31	Loss of communication with SCPM A2 board	SCPM A2 board does not respond	Compressor A2 shut down	Ditto	Ditto
32	Loss of communication with SCPM B1 board	SCPM B1 board does not respond	Compressor B1 shut down	Ditto	Ditto
33	Loss of communication with SCPM B2 board	SCPM B2 board does not respond	Compressor B2 shut down	Ditto	Ditto
34	Loss of communication with EXV board	4xDO board associated with the EXV does not respond	Unit shut down	Ditto	Ditto
35	Loss of communication with fan board #1	4xDO board controlling the first four fan stages does not respond	Unit shut down if number of fan stages by circuit is lower than three. Otherwise circuit A shut down.	Ditto	Ditto
36	Loss of communication with fan board # 2	4xDO board controlling the fan stages of circuit B does not respond	Circuit B shut down	Ditto	Ditto
37	Loss of communication with auxiliary board type 1	Board does not respond	Unit shut down if heating mode has been selected.	Automatic	Bus wiring fault, incorrect address or defective board
38	Loss of communication with heat reclaim or evaporator heater board	Analogue board does not respond	Unit shut down if heat reclaim mode is selected.	Automatic if board is again detected	Auxiliary board faulty Faulty connection
39	'CCN/clock board' fault	CCN/clock board is no longer detected	Unit shut down	Ditto	Defective CCN/clock board
40**	Control box thermostat fault or phase reversal	Sensor overheated	Unit shut down	Auto if the same alarm has not tripped the same day	Badly ventilated control box

Alarm code	Description	Why was this alarm generated?	Action taken by the control	Reset type	Probable cause
41	Unit emergency stop	CCN command to stop the unit received	Unit shut down	CCN/Automatic	Control network
42	Initial factory configuration required	All factory parameters are 0	Unit cannot start	Auto	No factory configuration
43-n	Illegal initial factory configuration	Bad factory configuration	Ditto	Ditto	Factory configuration error
43-1	Compr A capacity too high				
43-2	Compr B2 configured and compressor B1 absent				
43-3	Fan configured for a water-cooled condenser				
43-4	Fans not configured				
43-5	Heat reclaim option configured and reclaim sensors configured				
44	Discharge pressure circuit A too high	SCT>loadshed threshold. Max. satur. condensing pressure (mct_sp) if only one capacity stage remains in operation	Circuit A shut down	Auto in the 10mn that follow	Transducer/high pressure switch or fan circuit defective, water flow obstructed in the condenser, water entering temperature or condenser air too high
45	Discharge pressure circuit B too high	SCT>loadshed threshold. Max. satur. condensing pressure (mct_sp) if only one capacity stage remains in operation	Circuit B shut down	Ditto	Ditto
46	Oil solenoid failure, compressor A1	Oil pressure differential >17kPa during the period following pump start-up and before opening of the oil solenoid (see prelubrication)	Compressor A1 not authorised to start	Auto if the same alarm has not tripped the same day	Oil valve defective
47	Oil solenoid failure, compressor A2	Ditto	Compressor A2 not authorised to start	Ditto	Ditto
48	Oil solenoid failure, compressor B1	Ditto	Compressor B1 not authorised to start	Ditto	Ditto
49	Oil solenoid failure, compressor B2	Ditto	Compressor B2 not authorised to start	Ditto	Ditto
50	Pre-start oil pressure, compressor A1	Oil pump does not sufficiently increase the pressure during several prelubrication cycles	Compressor A1 cannot start	Ditto	Low oil level, oil pump, oil solenoid or oil transducer failure
51	Pre-start oil pressure, compressor A2	Oil pump does not sufficiently increase the pressure during several prelubrication cycles	Compressor A2 cannot start	Ditto	Ditto
52	Pre-start oil pressure, compressor B1	Oil pump does not sufficiently increase the pressure during several prelubrication cycles	Compressor B1 cannot start	Ditto	Ditto
53	Pre-start oil pressure, compressor B2	Oil pump does not sufficiently increase the pressure during several prelubrication cycles	Compressor B2 cannot start	Ditto	Ditto
54	Oil level circuit A low	Oil level control contact open during operation	Circuit A shut down	Manual	Oil level detector defective, oil quantity insufficient
55	Oil level circuit B low	Oil level control contact open during operation	Circuit B shut down	Manual	Ditto
56	Low saturated suction temp, circuit A	SST under defrost threshold* for 3 minutes	Circuit A shut down	Auto if the same alarm has not tripped the same day	Low refrigerant charge, filter drier obstructed, expansion valve and transducer defective, low water flow, low evaporator water temperature
57	Low saturated suction temp, circuit B	SST under defrost threshold* for 3 minutes	Circuit B shut down	Ditto	Ditto
58	High saturated suction temp, circuit A	After 90 seconds of operation if SST > 12.8°C & EXV < 1%	Circuit A shut down	Manual	Expansion valve, liquid level sensor or transducer defective, high evaporator temp.
59	High saturated suction temp, circuit B	After 90 seconds of operation if SST > 12.8°C & EXV < 1%	Circuit B shut down	Manual	Ditto
60	Low discharge superheat, circuit A	Superheat <2.8 K for 10 minutes	Circuit A shut down	Auto if the same alarm has not tripped the same day	Thermistor, transducer, EXV or economizer defective
61	Low discharge superheat, circuit B	Superheat <2.8 K for 10 minutes	Circuit B shut down	Ditto	Ditto
62	Max. oil pressure difference, compressor A1	(Discharge pressure - oil pressure) >340 kPa for more than 6 seconds	Compressor A1 shut down	Manual	Obstructed oil filter, oil solenoid or shut-off valve blocked, or manual oil valve closed
63	Max. oil pressure difference, compressor A2	(Discharge pressure - oil pressure) >340 kPa for more than 6 seconds	Compressor A2 shut down	Manual	Ditto
64	Max. oil pressure difference, compressor B1	(Discharge pressure - oil pressure) >340 kPa for more than 6 seconds	Compressor B1 shut down	Manual	Ditto
65	Max. oil pressure difference, compressor B2	(Discharge pressure - oil pressure) >340 kPa for more than 6 seconds	Compressor B2 shut down	Manual	Ditto
66	Loss of communication with System Manager	The unit is controlled by a System Manager (Flotronic or Chiller) and communication with this module is lost for more than two minutes	Unit returns to autonomous operating mode	Auto	Defective CCN BUS wiring or system module failure
67	Loss of communication with master or slave unit	The master/slave link is broken due to a loss of communication between the two units for more than 2 minutes	Unit returns to autonomous operating mode	Auto	Defective CCN BUS wiring or loss of supply

Alarm code	Description	Why was this alarm generated?	Action taken by the control	Reset type	Probable cause
68	Low oil pressure compr A1	Oil pressure differential below the setpoint (dynamically calculated) for 15 seconds	Compressor A1 shut down	Auto if the same alarm has not tripped the same day	Low condenser air or water temperature, oil filters obstructed, oil valve blocked, oil solenoid and oil pressure transducer defective
69	Low oil pressure compr A2	Oil pressure differential below the setpoint (dynamically calculated) for 15 seconds	Compressor A2 shut down	Ditto	Ditto
70	Low oil pressure compr B1	Oil pressure differential below oil setpoints 1 or 2 (see alert criteria for low oil pressure and setpoint)	Compressor B1 shut down	Ditto	Ditto
71	Low oil pressure compr B2	Oil pressure differential below the setpoint (dynamically calculated) for 15 seconds	Compressor B2 shut down	Auto if the same alarm has not tripped the same day	Ditto
72	Evaporator frost protection	1 - Evaporator EWT or LWT below defrost setpoint 2 - On units equipped with an evaporator heater, heater operates for more than 15 minutes but does not heat the evaporator	Unit shut down. Evaporator pump and if applicable heater start-up, if unit has shut down air-cooled units)	Ditto	Defective thermistor, low water flow
73	Condenser frost protection, circuit A	For water-cooled units and fluid type = water, if SCT<1,1°C	Unit shut down. Condenser pump start-up, if unit has shut down	Automatic	Discharge pressure transducer defective, refrigerant leak or low condenser water temperature
74	Condenser frost protection, circuit B	For water-cooled units and fluid type = water, if SCT<1,1°C	Unit shut down. Condenser pump start-up, if unit has shut down	Automatic	Ditto
75	Evaporator water flow control failure	1 - Control not closed, before end of the start-up delay or open during operation 2 - Pump shut down for 2 mins and water flow contact closed	Unit shut down. Pump shut down	Manual	Evaporator pump control or water flow switch failure
76	Condenser water flow loss	Water flow switch (water-cooled units) not closed during the minute after start-up	Unit shut down	Manual	Condenser pump, low water flow, water flow switch
77	High current, compressor A1	Current higher than threshold value detected	Compressor A1 shut down	Auto after 10 mn delay	Operation above the compressor capacity
78	High current, compressor A2	Ditto	Compressor A2 shut down	Ditto	Ditto
79	High current, compressor B1	Ditto	Compressor B1 shut down	Ditto	Ditto
80	High current, compressor B2	Ditto	Compressor B2 shut down	Ditto	Ditto
81	Pump 1 fault	Evaporator water pump contact open, when the pump has received a command to run	Unit shut down	Manual	Pump overheat or bad pump connection
82	Pump 2 fault	Ditto	Ditto	Manual	Ditto
83	Heat reclaim mode fault, circuit A	1. Interlock not closed 1 minute after condenser pump start-up or open during heat reclaim operation 2. More than two consecutive pumpdown sequences not successful.	Circuit A remains in cooling mode	Manual	1. Water flow switch defective. 2. Leak or heat reclaim shutoff or drain solenoid valve open.
84	Heat reclaim mode fault, circuit B	Ditto	Circuit B remains in cooling mode	Manual	Ditto
85	Water flow fault, heat reclaim condenser	Water flow detector (water-cooled units) not closed for one minute	Unit remains in cooling mode	Manual	Ditto
86-nn	Master/slave configuration fault	Bad master/slave configuration	Master/slave control not allowed	Auto/manual for heating/cooling mode fault	Master/slave configuration error
87-n	Maintenance alert	A maintenance alert is active	None	Manual	
87-1	Charge too low				
87-2	Water loop too low				
87-3	Air filter maintenance delay elapsed				
87-4	Pump 1 maintenance delay elapsed				
87-5	Pump 2 maintenance delay elapsed				
87-6	Water filter maintenance delay elapsed				

Alarm	Function	Description	Action	Reset	Note
1xx	Defect compressor A1	See SCPM subcodes below	See SCPM subcodes below	Manual	
2xx	Defect compressor A2	See SCPM subcodes below	See SCPM subcodes below	Manual	
3xx	Defect compressor B1	See SCPM subcodes below	See SCPM subcodes below	Manual	
4xx	Defect compressor B2	See SCPM subcodes below	See SCPM subcodes below	Manual	

SCPM subcodes (XX)

Alarm	Function	Description	Action	Reset	Note
01	High motor temperature	SCPM detects high motor temperature, if temperature is higher than 110°C for 10 seconds	Compressor shut down	Manual	Solenoid, cooling motor defect, low refrigerant charge. Wiring, motor temperature sensor or SCPM board fault
02	Motor temperature sensor	SCPM measures a temperature outside the -40°C to 118°C temperature range	Ditto	Manual	Thermistor, solenoid, motor cooling or wiring fault
03	High pressurestat tripped	HPS port to SCPM module open	Ditto	Manual	Lack of condenser water flow. Condenser valve blocked, fan circuit fault, high condenser entering air or water temperature
04	High motor current		Ditto	Manual	Operation outside the compressor capacity. Configuration block badly perforated, motor fault
05	Rotor blocked	SCPM detects high current, based on MTA rating	Ditto	Manual	Load too high
06	Ground current fault	SCPM detects ground current (2.5 +/- 0 amps)	Ditto	Manual	Ground current fault on motor winding, wiring fault
07	Current drop in one phase L1	SCPM measures a current drop > = 65%	Ditto	Manual	Motor fault, wiring fault
08	Current drop in one phase L2	SCPM measures a current drop > = 65%	Ditto	Manual	Motor fault, wiring fault
09	Current drop in one phase L3	SCPM measures a current drop > = 65%	Ditto	Manual	Motor fault, wiring fault
10	Current imbalance >14%	SCPM measures a current imbalance between phases as more than 14% for 25 minutes	None, simple message	Manual, if threshold alarm is validated. Otherwise auto reset.	Loss of power supply, wiring fault, loose terminal, core defective
11	Current imbalance >18%	SCPM measures a current imbalance between phases of more than 18% for 25 minutes	Compressor shut down, if threshold alarm is validated.	Ditto	Poor power supply, loose terminal, core defective
12	No motor current	SCPM module shows less than 10% of the MTA for more than 3 seconds	Shut down	Manual	Power supply interrupted, fuse(s) blown, wiring fault, core defective
13	Star-delta start-up		Compressor shut down	Manual	Defective connector
14	Contact failure	SCPM detects 10% of the MTA for 10 seconds after shutdown of the compressor contactor. Oil solenoid still has supply.	Unit shut down	Manual	Defective/blocked contactor
15	Compressor shut-down not possible		Circuit shut down	Manual	Contact stuck
16	Current phase reversal	SCPM detects a current phase reversal via the core	Compressor shut down	Manual	Supply phases or cables reversed, core wiring reversed after replacement
17	Configuration block fault	SCPM detects a reading fault at the block	Compressor shut down	Manual	Configuration block on SCPM board badly perforated or badly placed. Defective board.

Legend

* Defrost threshold = 1,1°C for water or for the lowest cooling setpoint less 4,4°C for brine or low brine.

** This safety circuit is controlled by two contacts, 16A and 16B, which are connected in series internally. If there is only a single control box there is a jumper on 16B, otherwise 16B controls the control box safety of the circuit. If one of the two contacts 16A and 16B is open, the whole unit is in fault status.

SCPM: Compressor protection module

FSM: Flotronic System Manager™

CSM: Chiller System Manager

MTA: Compressor Must Trip Amperes



Order No. 13054-76, 09.2007. Supersedes order No.: 13054-76, 04.2002
Manufacturer reserves the right to change any product specifications without notice.



Environmental Management System Approval

Manufactured by: Carrier SCS, Montluel, France.
Printed in the Netherlands.